

PUB-2M series DC/DC Converters
Isolated 2W Unregulated Single/Dual Output

28701-BMR807 Rev. C

March 2023

© Flex

Key Features

- Industry standard SMD package
12.75 x 11.2 x 8.0 mm (0.502 x 0.441 x 0.315 in) for Single output
15.25 x 11.2 x 8.0 mm (0.6 x 0.441 x 0.315 in) for Dual output
- High efficiency, typ. 86.5% at 12 Vout full load
- 3000 Vdc input to output isolation
- Wide operating temperature from -40°C to 110°C
- No minimum load required
- Output short-circuit protection
- 5 V, 12 V & 24 V input
- 5 V & 12 output
- MTBF 17.9 Mh

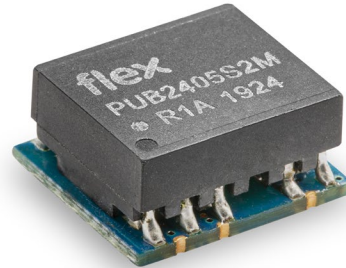

General Characteristics

- 2W output power
- Safety Compliance to EN/UL 62368-1
- ISO 9001/14001 certified supplier

Safety Approvals



Design for Environment



Meets requirements in high-temperature lead-free soldering processes.

Contents

Ordering Information	2
General Information	2
Safety Specification	3
Absolute Maximum Ratings	4
Electrical Specification	
5-24 Vi / 5-12 Vo, 0.167-0.4 A / 2 W	PUB-2M Series..... 5
EMC Specification	10
Operating Information	11
Thermal Consideration	12
Connections	12
Mechanical Information	13
Soldering Information	14
Delivery Information	14
Product Qualification Specification	15

Technical Specification

PUB-2M series DC/DC Converters
 Isolated 2W Unregulated Single/Dual Output

28701-BMR807 Rev. C

March 2023

© Flex

Ordering Information

Product	Nominal Input	Output
PUB0505S2M	5 V	5.0 V, 0.4 A / 2 W
PUB1205S2M	12 V	5.0 V, 0.4 A / 2 W
PUB2405S2M	24 V	5.0 V, 0.4 A / 2 W
PUB2412S2M	24 V	12 V, 0.167 A / 2 W
PUB2405D2M	24 V	±5.0 V, 0.2 A / 2 W

Product number and Packaging

PUB X ₁ X ₂ X ₃ X ₄ n ₁ n ₂ n ₃ *			
Options	n ₁	n ₂	n ₃
Single/Dual output	o		
Output Power		o	
Form factor			o

Options

Description

n ₁	S	Single Output
	D	Dual Output
n ₂	2	2W
n ₃	M	SMD

Example a 24Vdc nominal input, single 5Vdc output, 2W SMD product would be PUB2405S2M.

The products are delivered in tape and reel. See details in Delivery Package Information.

* X₁X₂ = Nominal input voltage

X₃X₄ = Output voltage (single/symmetric dual)

General Information**Reliability**

The failure rate (λ) and mean time between failures (MTBF = $1/\lambda$) is calculated at max output power and an operating ambient temperature (T_A) of +25°C. Flex uses MIL-HDBK-217F, Notice 2 to calculate the mean steady-state failure rate.

In MIL-HDBK-217F, all part reliability models include the effects of environmental stresses through the environmental factor, πE . It encompasses the major areas of equipment use, here we use ground benign, GB.

Mean steady-state failure rate, λ	MTBF
55.8 nFailures/h	17.9 Mh

Compatibility with RoHS requirements

The products are compatible with the relevant clauses and requirements of the RoHS directive 2011/65/EU and have a maximum concentration value of 0.1% by weight in homogeneous materials for lead, mercury, hexavalent chromium, PBB and PBDE and of 0.01% by weight in homogeneous materials for cadmium.

Exemptions in the RoHS directive utilized in Flex products are found in the Statement of Compliance document.

Flex fulfills and will continuously fulfill all its obligations under regulation (EC) No 1907/2006 concerning the registration, evaluation, authorization and restriction of chemicals (REACH) as they enter into force and is through product materials declarations preparing for the obligations to communicate information on substances in the products.

Quality Statement

The products are designed and manufactured in an industrial environment where quality systems and methods like ISO 9000, Six Sigma, and SPC are intensively in use to boost the continuous improvements strategy. Infant mortality or early failures in the products are screened out and they are subjected to an ATE-based final test. Conservative design rules, design reviews and product qualifications, plus the high competence of an engaged work force, contribute to the high quality of the products.

Warranty

Warranty period and conditions are defined in Flex General Terms and Conditions of Sale.

Limitation of Liability

Flex does not make any other warranties, expressed or implied including any warranty of merchantability or fitness for a particular purpose (including, but not limited to, use in life support applications, where malfunctions of product can cause injury to a person's health or life).

© Flex 2023

The information and specifications in this technical specification is believed to be correct at the time of publication. However, no liability is accepted for inaccuracies, printing errors or for any consequences thereof. Flex reserves the right to change the contents of this technical specification at any time without prior notice.

Technical Specification

PUB-2M series DC/DC Converters Isolated 2W Unregulated Single/Dual Output	28701-BMR807 Rev. C	March 2023
	© Flex	

Safety Specification

General information

Flex Power DC/DC converters and DC/DC regulators are designed in accordance with the safety standards IEC 62368-1, EN 62368-1 and UL 62368-1 *Audio/video, information and communication technology equipment - Part 1: Safety requirements*

IEC/EN/UL 62368-1 contains requirements to prevent injury or damage due to the following hazards:

- Electrical shock
- Electrically-caused fire
- Injury caused by hazardous substances
- Mechanically-caused injury
- Skin burn
- Radiation-caused injury

On-board DC/DC converters, Power interface modules and DC/DC regulators are defined as component power supplies. As components they cannot fully comply with the provisions of any safety requirements without “conditions of acceptability”. Clearance between conductors and between conductive parts of the component power supply and conductors on the board in the final product must meet the applicable safety requirements. Certain conditions of acceptability apply for component power supplies with limited stand-off (see Mechanical Information for further information). It is the responsibility of the installer to ensure that the final product housing these components complies with the requirements of all applicable safety standards and regulations for the final product.

Component power supplies for general use shall comply with the requirements in IEC/EN/UL 62368-1. Product related standards, e.g. IEEE 802.3af *Power over Ethernet*, and ETS-300132-2 *Power interface at the input to telecom equipment, operated by direct current (dc)* are based on IEC/EN/UL 62368-1 with regards to safety.

Flex Power DC/DC converters, Power interface modules and DC/DC regulators are UL 62368-1 recognized and certified in accordance with EN 62368-1. The flammability rating for all construction parts of the products meet requirements for V-0 class material according to IEC 60695-11-10, *Fire hazard testing, test flames – 50 W* horizontal and vertical flame test methods.

Isolated DC/DC converters & Power interface modules

The product may provide basic or functional insulation between input and output according to IEC/EN/UL 62368-1 (see Safety Certificate), different conditions shall be met if the output of a basic or a functional insulated product shall be considered as ES1 energy source.

For basic insulated products (see Safety Certificate) the output is considered as ES1 energy source if one of the

following conditions is met:

- The input source provides supplementary or double or reinforced insulation from the AC mains according to IEC/EN/UL 62368-1.
- The input source provides functional or basic insulation from the AC mains and the product’s output is reliably connected to protective earth according to IEC/EN/UL 62368-1.

For functional insulated products (see Safety Certificate) the output is considered as ES1 energy source if one of the following conditions is met:

- The input source provides double or reinforced insulation from the AC mains according to IEC/EN/UL 62368-1.
- The input source provides basic or supplementary insulation from the AC mains and the product’s output is reliably connected to protective earth according to IEC/EN/UL 62368-1.
- The input source is reliably connected to protective earth and provides basic or supplementary insulation according to IEC/EN/UL 62368-1 and the maximum input source voltage is 60 Vdc.

Galvanic isolation between input and output is verified in an electric strength test and the isolation voltage (V_{iso}) meets the voltage strength requirement for basic insulation according to IEC/EN/UL 62368-1.

It is recommended to use a slow blow fuse at the input of each DC/DC converter. If an input filter is used in the circuit the fuse should be placed in front of the input filter. In the rare event of a component problem that imposes a short circuit on the input source, this fuse will provide the following functions:

- Isolate the fault from the input power source so as not to affect the operation of other parts of the system
- Protect the distribution wiring from excessive current and power loss thus preventing hazardous overheating

Non - isolated DC/DC regulators

The DC/DC regulator output is ES1 energy source if the input source meets the requirements for ES1 according to IEC/EN/UL 62368-1.

Technical Specification

PUB-2M series DC/DC Converters
Isolated 2W Unregulated Single/Dual Output

28701-BMR807 Rev. C

March 2023

© Flex

Absolute Maximum Ratings

Characteristics		min	typ	max	Unit
T_{P1}	Operating Temperature (see Thermal Consideration section)	-40		+110	°C
T_S	Storage temperature	-55		+125	°C
V_I	Input voltage Range (base on nominal input voltage)	-10		+10	%
V_{iso}	Isolation voltage (input to output test voltage in 1minute)			3000	Vdc

Stresses above those listed under Absolute Maximum Ratings may cause permanent damage to the device. This is a stress rating only; functional operation of the device at these or any other conditions above those indicated in the Electrical Specification section of this specification is not implied. Exposure to absolute maximum rating conditions for extended periods may affect device reliability.

Fundamental Circuit Diagram

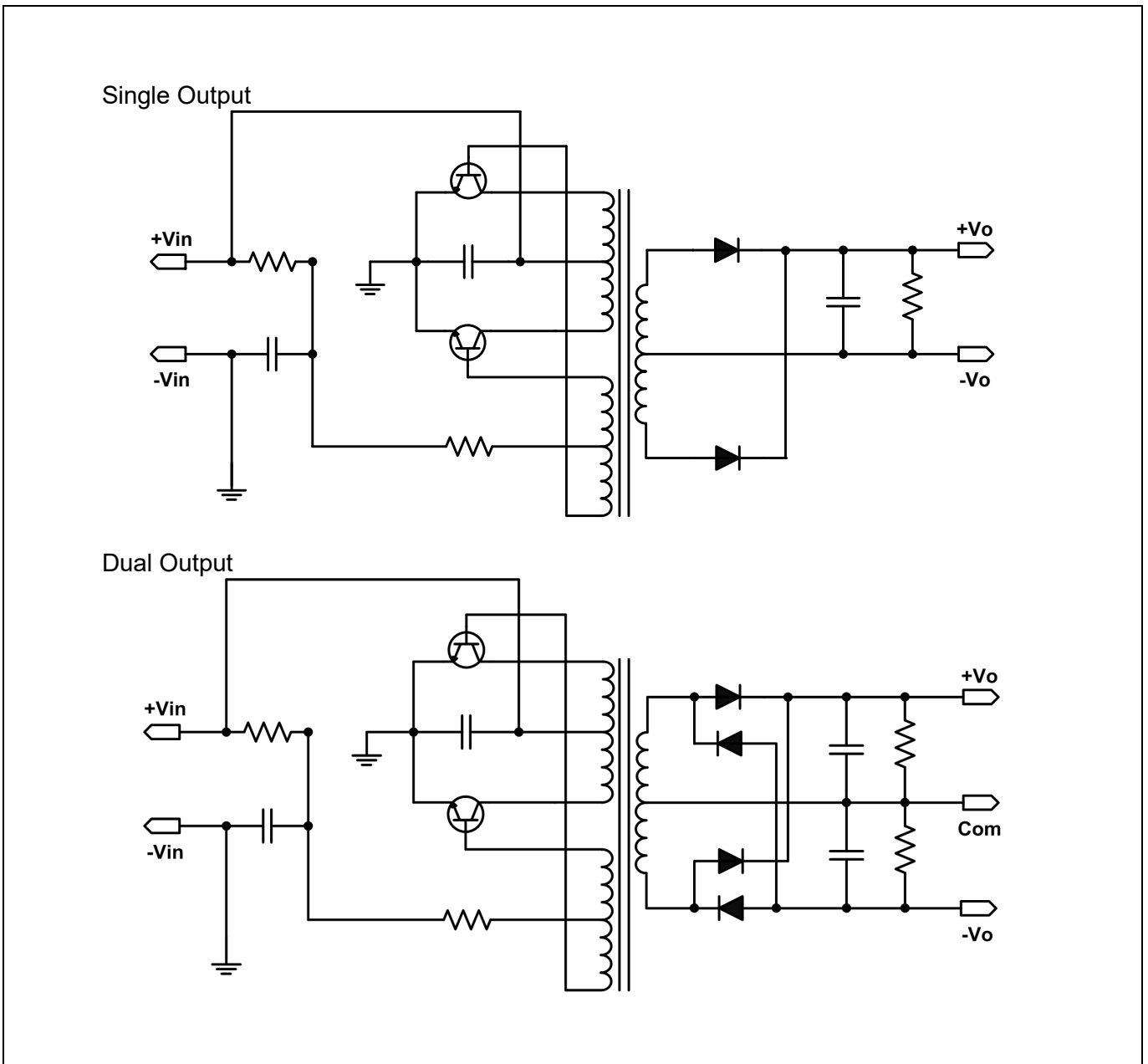

Technical Specification

PUB-2M series DC/DC Converters Isolated 2W Unregulated Single/Dual Output	28701-BMR807 Rev. C	March 2023
	© Flex	

Electrical Specification**PUB-2M series**

Typical values given at: $T_{P1} = +25^{\circ}\text{C}$, unless otherwise specified under Conditions.

Part Number	Input Voltage ($\pm 10\%$)	Output Voltage	Output Current	Efficiency (typ.) half of max I_o	Efficiency (typ.) max I_o	Capacitive Load ^{note 1}
	V	V	A	%	%	μF
PUB0505S2M	5	5	0.4	74	78.8	680
PUB1205S2M	12	5	0.4	78	80	680
PUB2405S2M	24	5	0.4	78	82.6	680
PUB2412S2M	24	12	0.167	79	86.5	150
PUB2405D2M	24	± 5	0.2	78	83	330

Characteristics		Conditions	min	typ	max	Unit
C_i	Internal input capacitance			1		μF
P_o	Output power				2	W
C_{ISO}	Isolation capacitance			95		pF
R_{ISO}	Isolation resistance		10			$\text{G}\Omega$
V_{oi}	Voltage accuracy	$T_{P1} = +25^{\circ}\text{C}$, $I_o = \text{max } I_o$	-5		+5	$\%V_o$
	Minimum load	$T_{P1} = +25^{\circ}\text{C}$	0			A
	Line regulation	V_{LL} to V_{HL} , max I_o		1.2	1.3	$\%V_o$
	Load regulation	$V_o = 5\text{ V}$, $I_{LL} - I_{HL}$, at typ. V_{in} $V_o = 12\text{ V} / \pm 5\text{ V}$, $I_{LL} - I_{HL}$, at typ. V_{in}		7.5	10	$\%V_o$
f_s	Switching frequency	0-100 % of max I_o	20			kHz
V_{Oac}	Output ripple & noise	20 MHz bandwidth limit, see Note 2			150	mVp-p

Note 1: The maximum capacitive load is test by normal input and constant resistive load.

Note 2: The Output ripple & noise is under nominal V_{in} and max I_o with 0.1 $\mu\text{F}/50\text{ V}$ MLCC

Technical Specification

PUB-2M series DC/DC Converters
Isolated 2W Unregulated Single/Dual Output

28701-BMR807 Rev. C

March 2023

© Flex

Typical Characteristics

Efficiency

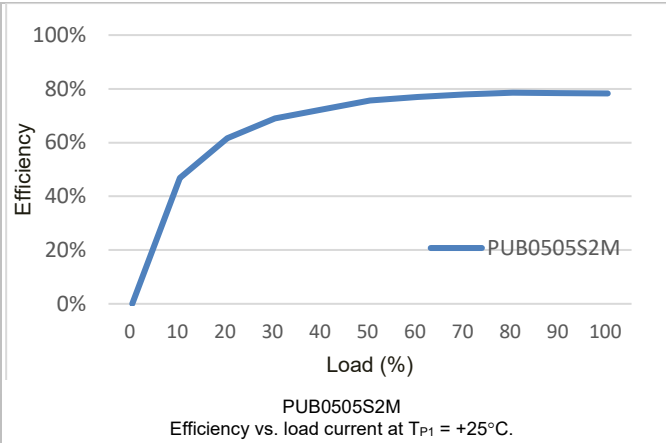

PUB-2M series

Efficiency

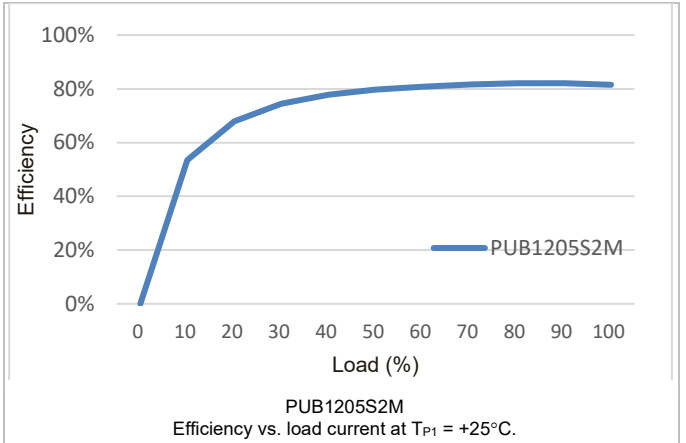

Efficiency

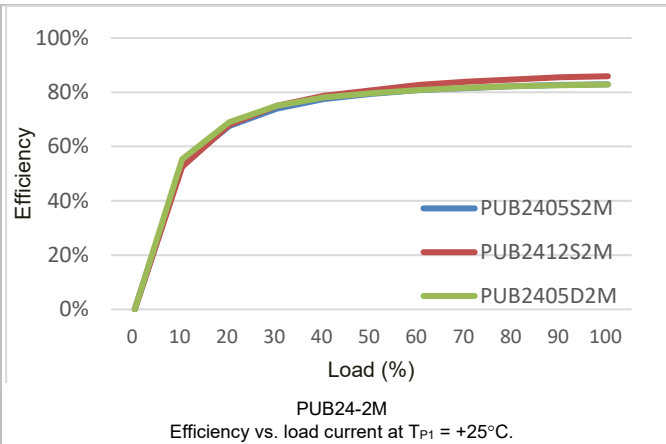

Operating Ambient Temperature Curve

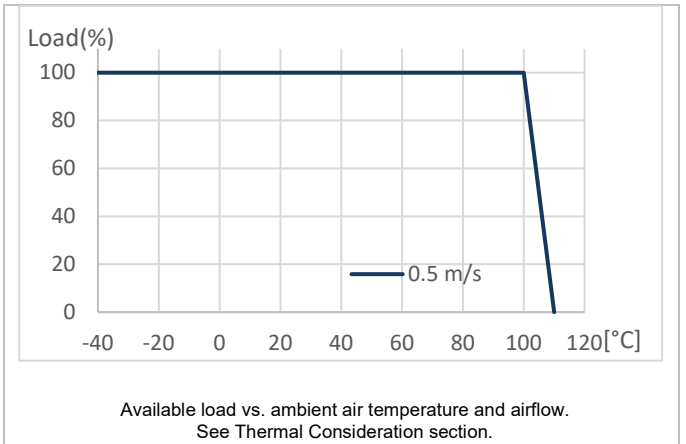

Output Voltage Accuracy

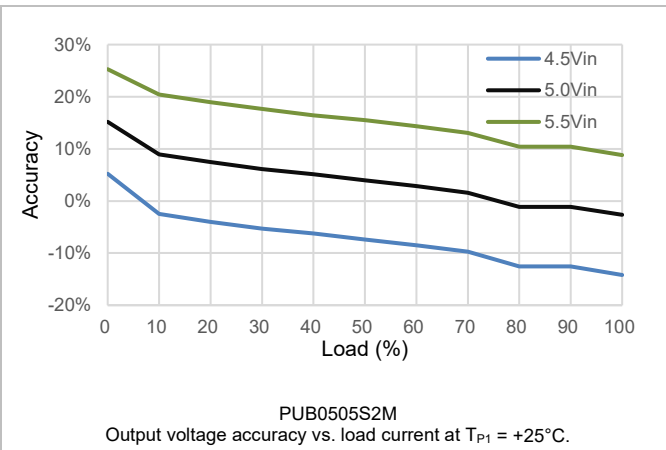

Output Voltage Accuracy

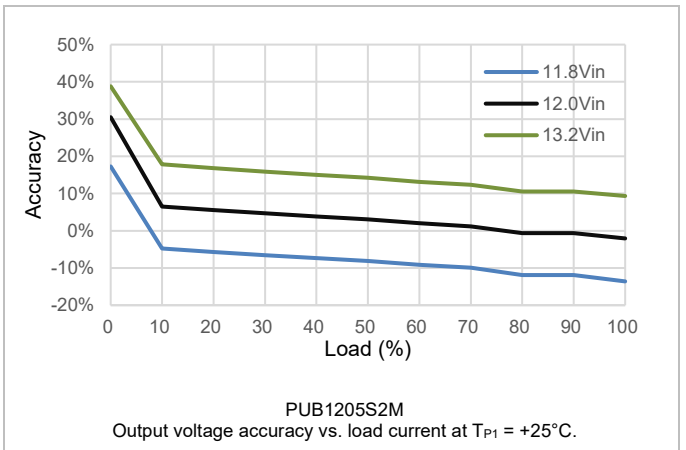

PUB-2M series DC/DC Converters
Isolated 2W Unregulated Single/Dual Output

28701-BMR807 Rev. C

March 2023

© Flex

Typical Characteristics
Output Voltage Accuracy

PUB-2M series

Load Regulation

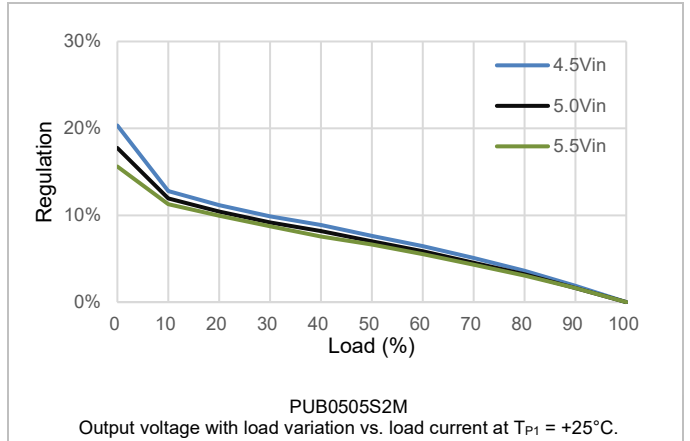
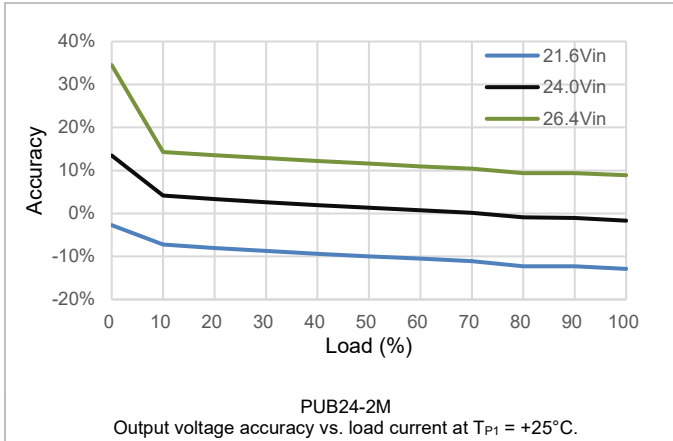

Load Regulation

Load Regulation

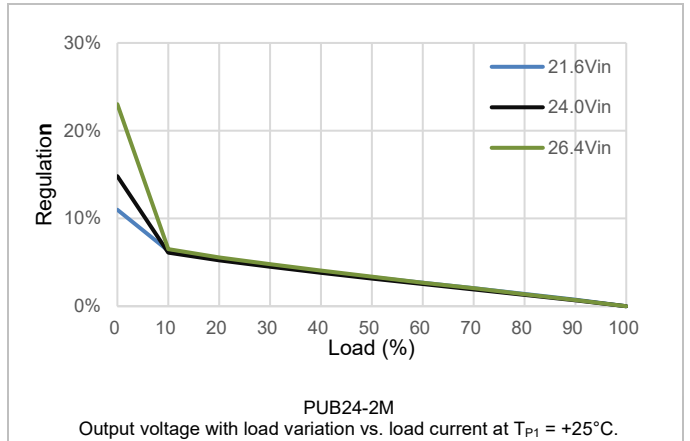
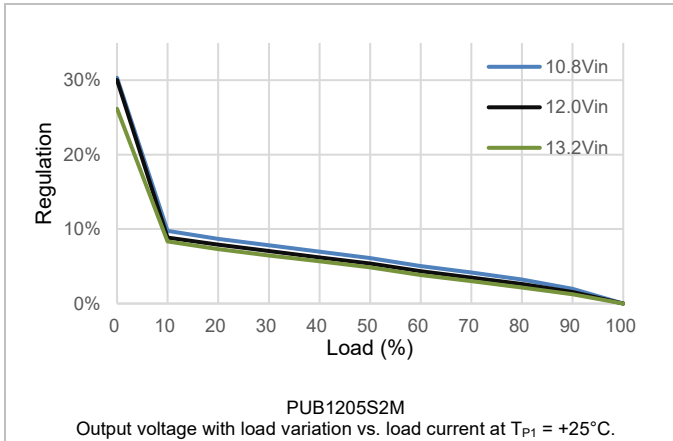

Output Ripple & Noise

Output Ripple & Noise

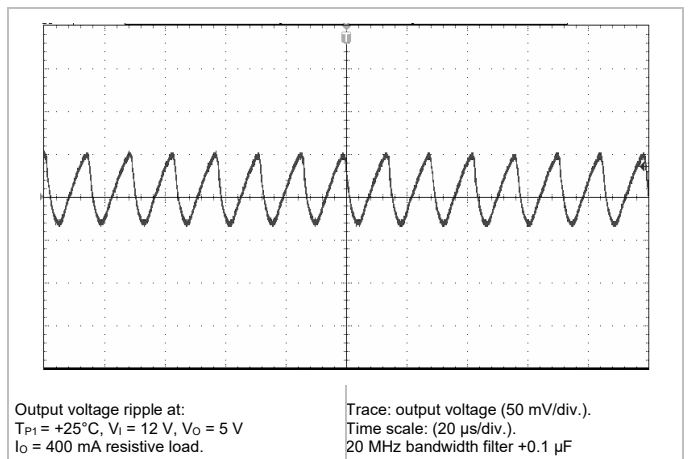
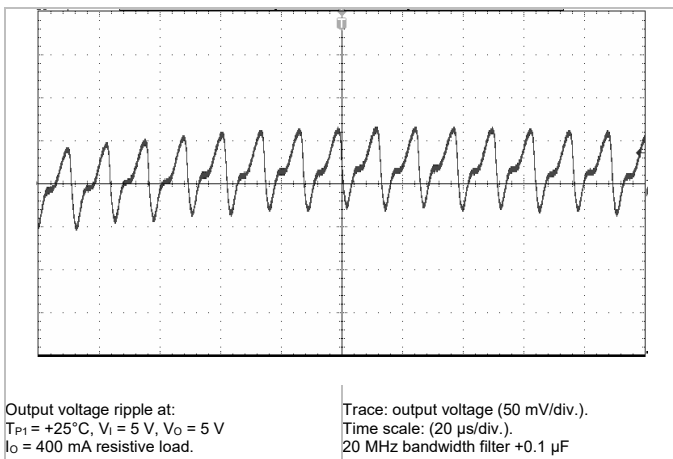

PUB-2M series DC/DC Converters
Isolated 2W Unregulated Single/Dual Output

28701-BMR807 Rev. C

March 2023

© Flex

Typical Characteristics

PUB-2M series

Output Ripple & Noise

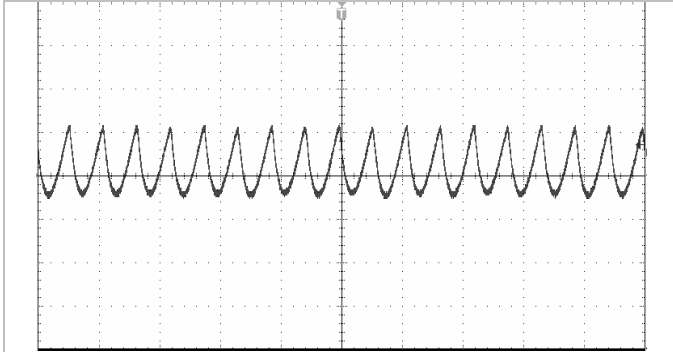

Output voltage ripple at:
 $T_{P1} = +25^{\circ}\text{C}$, $V_I = 24\text{ V}$, $V_O = 5\text{ V}$
 $I_O = 400\text{ mA}$ resistive load.

Trace: output voltage (50 mV/div.).
Time scale: (20 μs /div.).
20 MHz bandwidth filter +0.1 μF

Start-up

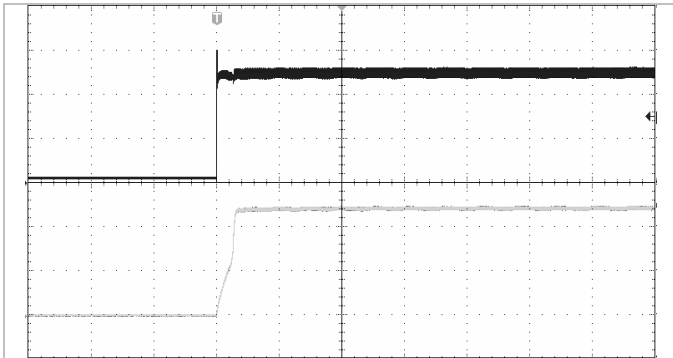

Start-up, enabled by connecting V_I at:
 $T_{P1} = +25^{\circ}\text{C}$, $V_I = 5\text{ V}$, $V_O = 5\text{ V}$
 $I_O = 400\text{ mA}$ resistive load.

Top trace: Input voltage (2 V/div.).
Bottom trace: Output voltage (2 V/div.).
Time scale: (1 ms/div.).

Shut-down

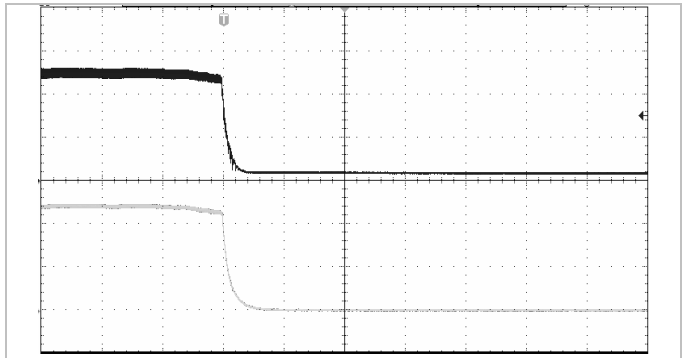

Shut-down, closed by disconnecting V_I at:
 $T_{P1} = +25^{\circ}\text{C}$, $V_I = 5\text{ V}$, $V_O = 5\text{ V}$
 $I_O = 400\text{ mA}$ resistive load.

Top trace: Input voltage (2 V/div.).
Bottom trace: Output voltage (2 V/div.).
Time scale: (1 ms/div.).

Start-up

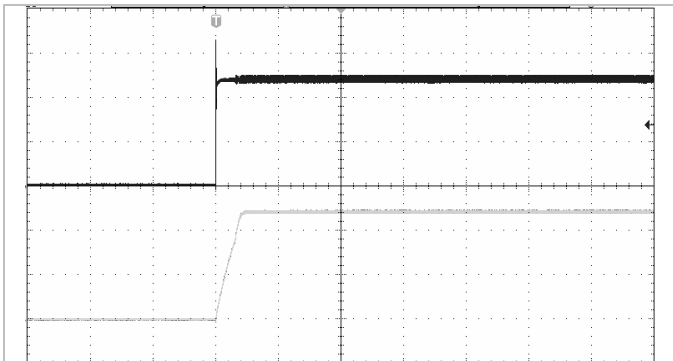

Start-up, enabled by connecting V_I at:
 $T_{P1} = +25^{\circ}\text{C}$, $V_I = 12\text{ V}$, $V_O = 5\text{ V}$
 $I_O = 400\text{ mA}$ resistive load.

Top trace: Input voltage (5 V/div.).
Bottom trace: Output voltage (2 V/div.).
Time scale: (1 ms/div.).

Shut-down

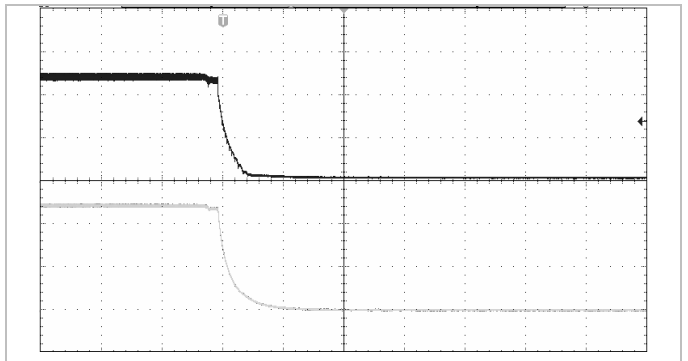

Shut-down, closed by disconnecting V_I at:
 $T_{P1} = +25^{\circ}\text{C}$, $V_I = 12\text{ V}$, $V_O = 5\text{ V}$
 $I_O = 400\text{ mA}$ resistive load.

Top trace: Input voltage (5 V/div.).
Bottom trace: Output voltage (2 V/div.).
Time scale: (1 ms/div.).

PUB-2M series DC/DC Converters
 Isolated 2W Unregulated Single/Dual Output

28701-BMR807 Rev. C

March 2023

© Flex

Typical Characteristics

PUB-2M series

Start-up

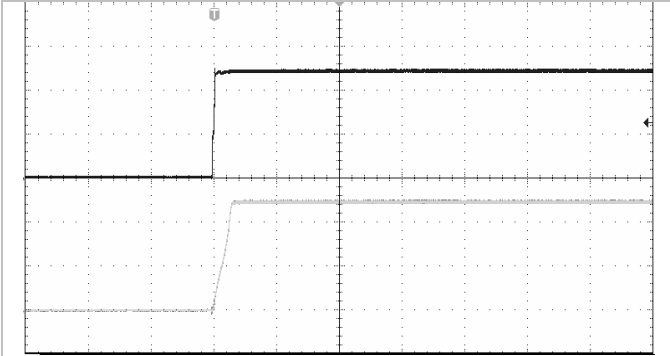

Start-up, enabled by connecting V_i at:
 $T_{P1} = +25^\circ\text{C}$, $V_i = 24\text{ V}$, $V_o = 5\text{ V}$
 $I_o = 400\text{ mA}$ resistive load.

Top trace: Input voltage (10 V/div.).
 Bottom trace: Output voltage (2 V/div.).
 Time scale: (1 ms/div.).

Shut-down

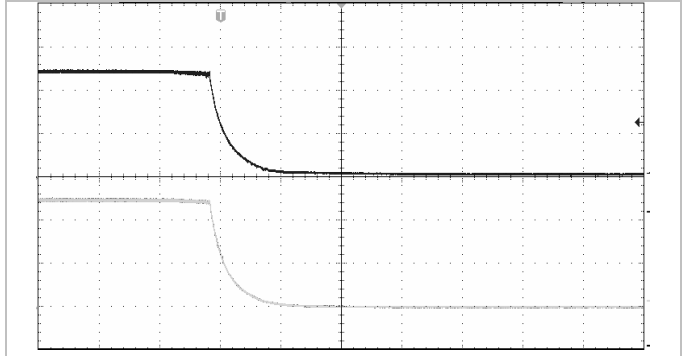

Shut-down, closed by disconnecting V_i at:
 $T_{P1} = +25^\circ\text{C}$, $V_i = 24\text{ V}$, $V_o = 5\text{ V}$
 $I_o = 400\text{ mA}$ resistive load.

Top trace: Input voltage (10 V/div.).
 Bottom trace: Output voltage (2 V/div.).
 Time scale: (1 ms/div.).

Technical Specification

PUB-2M series DC/DC Converters
Isolated 2W Unregulated Single/Dual Output

28701-BMR807 Rev. C

March 2023

© Flex

EMC Specification

Conducted EMI measured according to EN55032, CISPR 32 and FCC part 15J (see test set-up). See Design Note 029 for further information. The minimum switching frequency is 20 kHz. The EMI characteristics below is measured at normal input and max I_o.

Optional external filter for class B

Suggested external input filter in order to meet class B in EN 55032, CISPR 32 and FCC part 15J.

EMI external circuit

Series	L1	C1
PUB05-2M	22μH	4.7μF
PUB12-2M	47μH	22μF
PUB24-2M	47μH	22μF

Based on different applications or PCB layout conditions, the EMI requirement may be varied. Recommend to reserve Cy1 for better EMI performance. Depending on the different requirement of end users, the value of Cy1 could be adjusted from 33pF to 470pF.

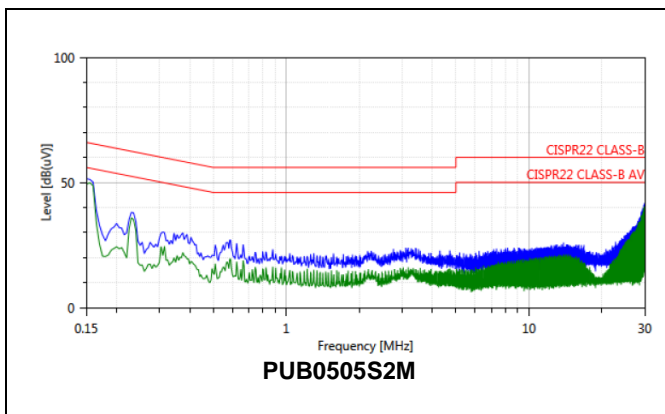

EMI with filter

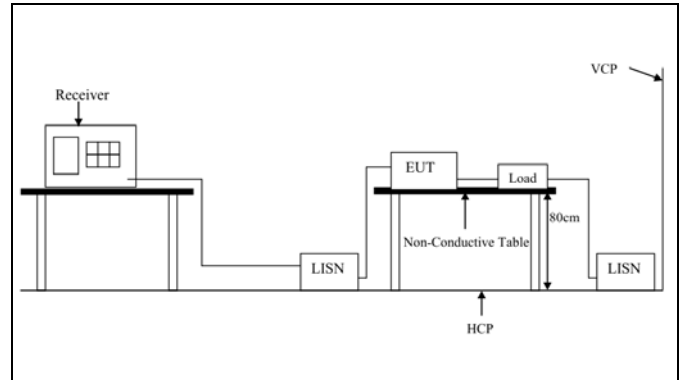

Test set-up

Layout recommendations

The radiated EMI performance of the product will depend on the PWB layout and ground layer design. It is also important to consider the stand-off of the product. If a ground layer is used, it should be connected to the output of the product and to the equipment ground or chassis.

A ground layer will increase the stray capacitance in the PWB and improve the high frequency EMC performance.

Output ripple and noise

Output ripple and noise is measured according to figure below. See Design Note 022 for detailed information.

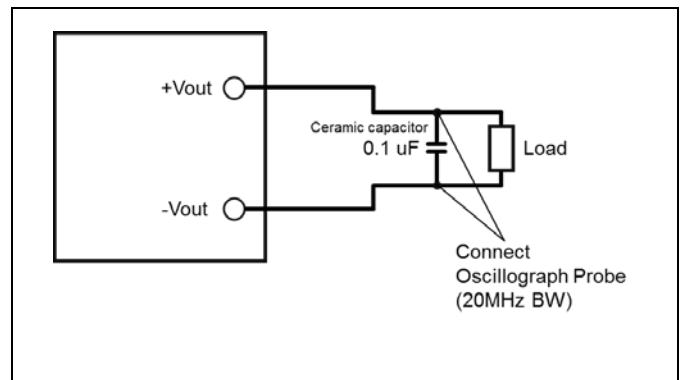

Output ripple and noise test setup

Technical Specification

PUB-2M series DC/DC Converters Isolated 2W Unregulated Single/Dual Output	28701-BMR807 Rev. C	March 2023
	© Flex	

Operating Information**Input Voltage**

Converter with 10% input voltage range, mainly for isolated power in industrial applications. For example, the input voltage range 4.5 to 5.5 Vdc meets requirement of general industrial used for 5Vdc system.

The input voltage should never exceed the absolute voltage of the converter, and the ambient temperature must be limited to absolute max +110°C.

The output voltage related to input voltage. Take 5Vin and 5Vo product as an example, if input voltage above 5V, the output voltage will higher than 5V. Below 5V and the output voltage starts to track the input voltage.

Short duration transient disturbances can occur on the DC distribution and input of the product when a short circuit fault occurs on the equipment side of a protective device (fuse or circuit breaker). The voltage level, duration and energy of the disturbance are dependent on the particular DC distribution network characteristics and can be sufficient to damage the product unless measures are taken to suppress or absorb this energy. The transient voltage can be limited by capacitors and other energy absorbing devices like Zener diodes connected across the positive and negative input conductors at a number of strategic points in the distribution network. The end-user must secure that the transient voltage will not exceed the value stated in the Absolute maximum ratings. ETSI TR 100 283 examines the parameters of DC distribution networks and provides guidelines for controlling the transient and reduce its harmful effect.

Turn-off Input Voltage

The products do not have under voltage lock-out function. Please make sure the input voltage of each module is correct working range.

Input and Output Impedance

The impedance of both the input source and the load will interact with the impedance of the product. It is important that the input source has low characteristic impedance. The product are designed for stable operation without external capacitors. With a 10 μ F capacitors connected to the input could reduce the input noise cause by parasitic inductance.

External Decoupling Capacitors

When powering loads with significant dynamic current requirements, the voltage regulation at the load can be improved by addition of decoupling capacitors at the load. The most effective technique is to locate low ESR ceramic and electrolytic capacitors as close to the load as possible, using several parallel capacitors to lower the effective ESR. The ceramic capacitors will handle high-frequency dynamic load

changes while the electrolytic capacitors are used to handle low frequency dynamic load changes. It is equally important to use low resistance and low inductance PWB layouts and cabling.

External decoupling capacitors will become part of the product's control loop. The control loop is optimized for a wide range of external capacitance and the maximum and minimum recommended value that could be used without any additional analysis is found in the Electrical specification. The ESR of the capacitors is a very important parameter. Stable operation is guaranteed with a verified ESR value of >1 m Ω across the output connections.

For further information please contact your local Flex Power Modules representative.

Parallel Operation

This product is not designed for paralleling without using external current sharing circuits.

See Design Note 006 for detailed information.

Over Current Protection (OCP)

The products include current limiting circuitry for protection at continuous overload. The OCP works in a hiccup mode and will make continuous attempts to start up and will resume normal operation automatically after removal of the over current condition. The load distribution should be designed for the specified maximum output short circuit current.

Technical Specification

PUB-2M series DC/DC Converters
Isolated 2W Unregulated Single/Dual Output

28701-BMR807 Rev. C

March 2023

© Flex

Thermal Consideration

General

The products are designed to operate in different thermal environments and sufficient cooling must be provided to ensure reliable operation.

For products mounted on a PWB without a baseplate attached, cooling is achieved mainly by conduction, from the pins to the host board, and convection, which is dependant on the airflow across the product. Increased airflow enhances the cooling of the product. The Output Current Derating graph found in the Output section for each model provides the available output current vs. ambient air temperature and air velocity.

The product is tested on a 95 x 85 mm, 35 µm (1 oz), 2-layer test board mounted horizontally in a space with a volume of 300(L) x 300(W) x 200(H) mm.

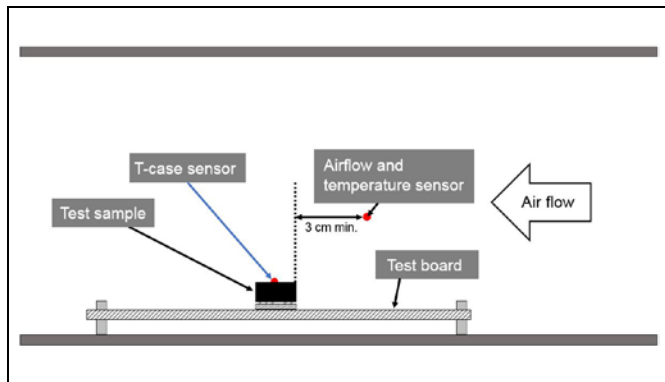

Definition of product operating temperature

The temperature at the positions P1, P2 (T_{P1} , T_{P2}) should not exceed the maximum temperatures in the table below. The number of measurement points may vary with different thermal design and topology. Temperatures above maximum measured at the reference points P1, P2 are not allowed and may cause permanent damage.

Position	Description	Max Temp.
P1	Driver, Reference point	$T_{P1}=110^{\circ}\text{C}$
P2	PWB	$T_{P2}=110^{\circ}\text{C}$

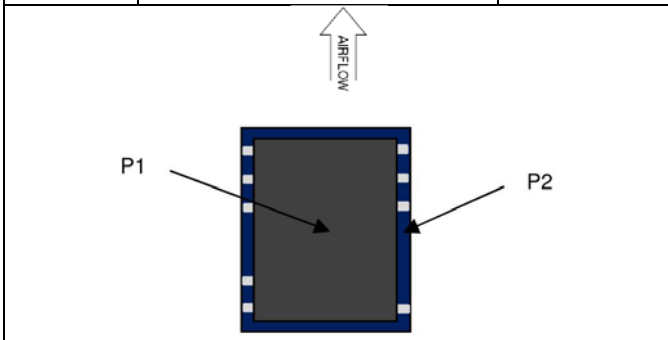

Pin side (baseplate module)

Connections

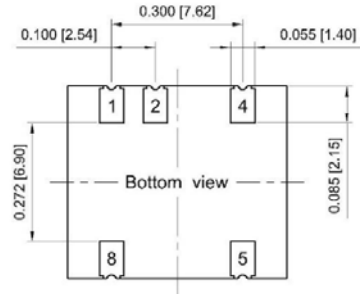

Bottom View

PUBxxxxS2M single output series

Pin	Designation	Function
1	-Vin	Negative Input
2	+Vin	Positive Input
4	-Vo	Negative Output
5	+Vo	Positive Output
8	NC	No-connect

Connections

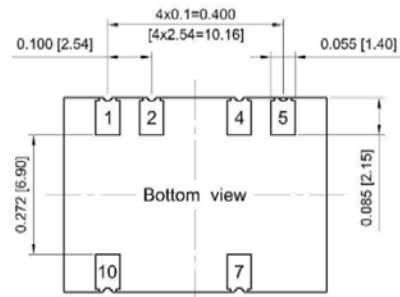

Bottom View

PUBxxxxD2M dual output series

Pin	Designation	Function
1	-Vin	Negative Input
2	+Vin	Positive Input
4	COM	Common
5	-Vo	Negative Output
7	+Vo	Positive Output
10	NC	No-connect

Technical Specification

PUB-2M series DC/DC Converters
Isolated 2W Unregulated Single/Dual Output

28701-BMR807 Rev. C

March 2023

© Flex

Mechanical Information - Surface Mounting Version

PUBxxxxS2M

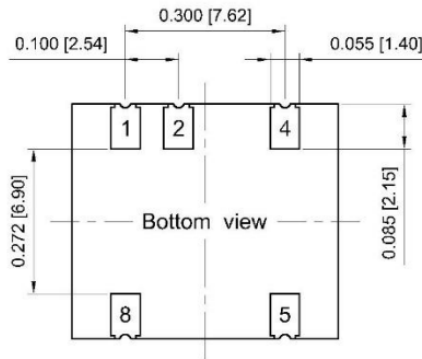
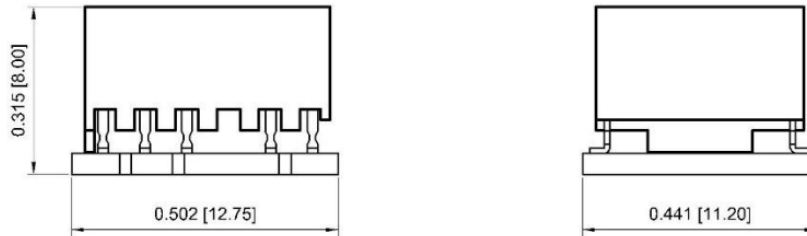

All Dimensions Inches(mm)
Tolerance Inches Millimeters
X.XX±0.02 X.X±0.5
X.XXX±0.01 X.XX±0.25

PUBxxxxD2M

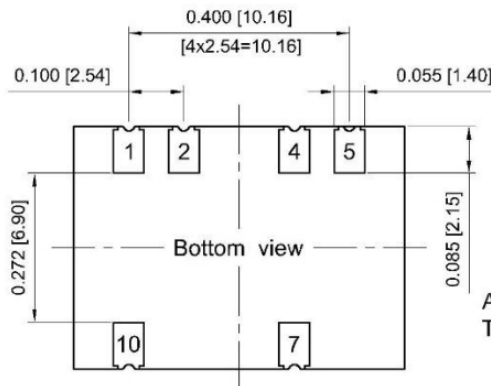
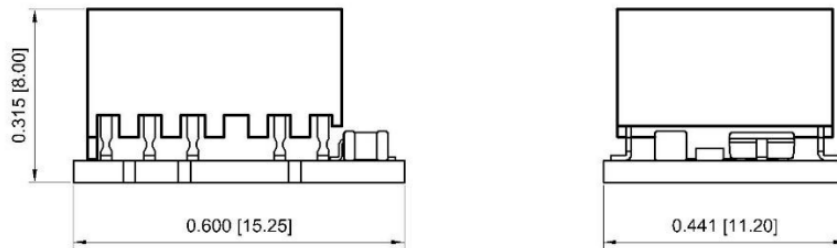

All Dimensions Inches(mm)
Tolerance Inches Millimeters
X.XX±0.02 X.X±0.5
X.XXX±0.01 X.XX±0.25

All component placements – whether shown as physical components or symbolical outline – are for reference only and are subject to change throughout the product's life cycle, unless explicitly described and dimensioned in this drawing.

Technical Specification

PUB-2M series DC/DC Converters
Isolated 2W Unregulated Single/Dual Output

28701-BMR807 Rev. C

March 2023

© Flex

Soldering Information - Surface Mounting

The surface mount product is intended for forced convection or vapor phase reflow soldering in SnPb and Pb-free processes.

The reflow profile should be optimised to avoid excessive heating of the product. It is recommended to have a sufficiently extended preheat time to ensure an even temperature across the host PWB and it is also recommended to minimize the time in reflow.

A no-clean flux is recommended to avoid entrapment of cleaning fluids in cavities inside the product or between the product and the host board, since cleaning residues may affect long time reliability and isolation voltage.

General reflow process specifications		Pb-free
Average ramp-up ($T_{PRODUCT}$)		3°C/s max
Typical solder melting (liquidus) temperature	T_L	221°C
Minimum reflow time above T_L		60 s
Minimum pin temperature	T_{PIN}	235°C
Peak product temperature	$T_{PRODUCT}$	250°C
Average ramp-down ($T_{PRODUCT}$)		6°C/s max
Maximum time 25°C to peak		8 minutes

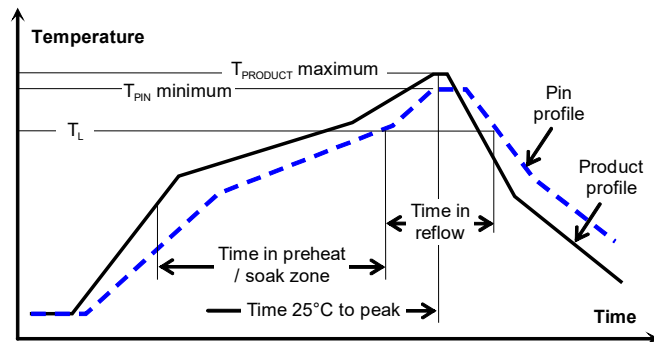

Minimum Pin Temperature Recommendations

Pin near the tail is chosen as reference location for the minimum pin temperature recommendation since this will likely be the coolest solder joint during the reflow process.

Lead-free (Pb-free) solder processes

For Pb-free solder processes, a pin temperature (T_{PIN}) in excess of the solder melting temperature (T_L , 217 to 221°C for SnAgCu solder alloys) for more than 60 seconds and a peak temperature of 245°C on all solder joints is recommended to ensure a reliable solder joint.

Maximum Product Temperature Requirements

Top of the product PWB near front center is chosen as reference location for the maximum (peak) allowed product temperature ($T_{PRODUCT}$) since this will likely be the warmest part of the product during the reflow process.

Pb-free solder processes

For Pb-free solder processes, the product is qualified for MSL 1 according to IPC/JEDEC standard J-STD-020C. During reflow $T_{PRODUCT}$ must not exceed 250 °C at any time.

Thermocouple Attachment

Top of PWB near front center for measurement of maximum product temperature, $T_{PRODUCT}$

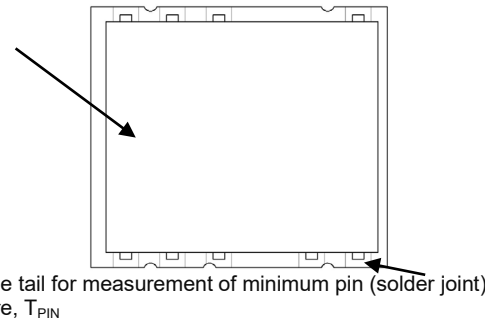

Delivery Package Information

The products are delivered in antistatic tape & reel.

Tape reel Specifications – SMD	
Material	Antistatic PS
Surface resistance	$10^5 < \text{Ohm/square} < 10^{12}$
Tape reel weight	4.5 kg full tray for PUB-S2M 5.0 kg full tray for PUB-D2M
Module weight	1.4 g / pc for PUB-S2M 1.6 g / pc for PUB-D2M

PUB-2M series

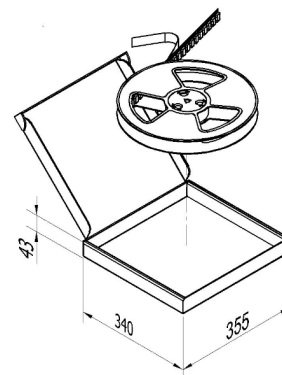

1 Tape Reel = 300 converters

1Tape Reel = 300 converters for PUBxxxxS2M

1Tape Reel = 300 converters for PUBxxxxD2M

All dimensions in mm

Note: pick up positions refer to center of pocket.

See mechanical drawing for exact location on product.

Technical Specification

PUB-2M series DC/DC Converters Isolated 2W Unregulated Single/Dual Output	28701-BMR807 Rev. C	March 2023
	© Flex	

Product Qualification Specification

Characteristics			
External visual inspection	IPC-A-610		
Change of temperature (Temperature cycling)	MIL-STD-202G, method 107G	Temperature range Number of cycles Dwell/transfer time	-55 to 125°C 1000 30 min/0-1 min
Cold (in operation)	IEC 60068-2-1 Ad	Temperature T _A Duration	-40°C 72 h
Damp heat	MIL-STD-202G, Method 103B	Temperature Humidity Duration	85°C 95 % RH 1000 hours
Dry heat	IEC 60068-2-2 Bd	Temperature Duration	125°C 1000 h
Electrostatic discharge susceptibility	IEC 61000-4-2	Air model Contact model	8000 V 6000 V
Mechanical shock	MIL-STD-202G, method 213B	Peak acceleration Duration	100 g 6 ms
Moisture reflow sensitivity ¹	J-STD-020C	Level 1 (Pb Free)	250°C
Operational life test	MIL-STD-202G, method 108A	Duration	1000 h
Robustness of terminations	IEC 60068-2-21 Test Ua1 IEC 60068-2-21 Test Ue1	Through hole mount products Surface mount products	All leads All leads
Solderability	J-STD-002	Preconditioning Temperature, Pb-free	Steam ageing 8 h 245°C
Vibration	MIL-STD-202G, method 201A	Frequency Displacement Duration	10 to 55 Hz 0.06 inch 2 h in each direction

Notes

¹ Only for products intended for reflow soldering (surface mount products)