

**BMR490 series** Non-isolated DC-DC Converters  
 Input 40-60 V, Output up to 139 A / 1300 W

28701-BMR490 Rev D      September 2020

© Flex

### Key Features

- Industry standard low profile Quarter-brick 58.4 x 36.8 x 14.5 mm (2.30 x 1.45 x 0.57 in)
- High efficiency, typ. 97.7 % at 51 Vin, half load
- Input to output non-isolated
- Baseplate to enhance thermal performance
- UL 62368 certificated
- Pin in paste soldering supported
- MTBF over 6 Million hours



### General Characteristics

- Input voltage range: 40-60 V
- Output voltage: 12 V
- Max output current: 139 A
- Max output power: 1300 W
- Monotonic start-up
- Output over voltage protection
- Over temperature protection
- Output short-circuit protection
- Remote control
- Highly automated manufacturing ensures quality
- ISO 9001/14001 certified supplier

### Safety Approvals



### Design for Environment



Meets requirements in high-temperature lead-free soldering processes.

### Contents

Ordering Information	2
General Information	2
Safety Specification	3
Absolute Maximum Ratings	4
Electrical Specification	
12 V, 139 A / 1300 W	BMR490 3317/820..... 8
EMC Specification	11
Operating Information	14
Thermal Consideration	18
Connections	19
Mechanical Information	20
Soldering Information	21
Delivery Information	22
Product Qualification Specification	24
PMBus commands	25

## Technical Specification

**BMR490 series** Non-isolated DC-DC Converters  
Input 40-60 V, Output up to 139 A / 1300 W

28701-BMR490 Rev D September 2020

© Flex

### Ordering Information

Product program	Vin	Output
BMR490 3317 / 820	40 - 60	12 V / 139 A, 1300 W, baseplate

### Product number and Packaging

BMR490	n <sub>1</sub>	n <sub>2</sub>	n <sub>3</sub>	n <sub>4</sub>	/	n <sub>5</sub>	n <sub>6</sub>	n <sub>7</sub>	n <sub>8</sub>
Mechanical option	x				/				
Baseplate		x			/				
Hardware option			x	x	/				
Configuration file					/	x	x	x	
Delivery package									x

Options	Description
n <sub>1</sub>	3 = Lead length 4.57 mm(0.180 in.)
n <sub>2</sub>	3 = Baseplate with screws
n <sub>3</sub> n <sub>4</sub>	17 = 40-60 Vin, 12 Vout, 1300W, non-isolated, DOSA 4 pin digital interface
n <sub>5</sub> n <sub>6</sub> n <sub>7</sub>	820 = CDA Configuration for 40-60 Vin, 12V/1300W, DOSA 4 digital interface, n <sub>3</sub> n <sub>4</sub> = 17  xxx = Application Specific Configuration
n <sub>8</sub>	E = pin in paste & soft tray H = pin in paste & hard tray

Example: a 12V/ 1300W operating at 40-60Vin, through-hole mounted, 4.57mm standard pin product with baseplate, with DOSA 4-pin digital interface, and hard tray package would be BMR480 3317/820H

### General Information

#### Reliability

The failure rate ( $\lambda$ ) and mean time between failures (MTBF=  $1/\lambda$ ) is calculated at max output power and an operating ambient temperature (T<sub>A</sub>) of +40°C. Flex Power Modules uses Telcordia SR-332 Issue 4 Method 1 to calculate the mean steady-state failure rate and standard deviation ( $\sigma$ ).

Telcordia SR-332 Issue 4 also provides techniques to estimate the upper confidence levels of failure rates based on the mean and standard deviation.

Mean steady-state failure rate, $\lambda$	Std. deviation, $\sigma$
148 nFailures/h	8 nFailures/h

MTBF (mean value) for the BMR480 series = 7.26 Mh.  
MTBF at 90% confidence level = 6.75 Mh

#### Compatibility with RoHS requirements

The products are compatible with the relevant clauses and requirements of the RoHS directive 2011/65/EU and have a maximum concentration value of 0.1% by weight in

homogeneous materials for lead, mercury, hexavalent chromium, PBB and PBDE and of 0.01% by weight in homogeneous materials for cadmium.

Exemptions in the RoHS directive utilized in Flex Power Modules products are found in the Statement of Compliance document.

Flex Power Modules fulfills and will continuously fulfill all its obligations under regulation (EC) No 1907/2006 concerning the registration, evaluation, authorization and restriction of chemicals (REACH) as they enter into force and is through product materials declarations preparing for the obligations to communicate information on substances in the products.

### Quality Statement

The products are designed and manufactured in an industrial environment where quality systems and methods like ISO 9000, Six Sigma, and SPC are intensively in use to boost the continuous improvements strategy. Infant mortality or early failures in the products are screened out and they are subjected to an ATE-based final test. Conservative design rules, design reviews and product qualifications, plus the high competence of an engaged work force, contribute to the high quality of the products.

### Warranty

Warranty period and conditions are defined in Flex Power Modules General Terms and Conditions of Sale.

### Limitation of Liability

Flex Power Modules does not make any other warranties, expressed or implied including any warranty of merchantability or fitness for a particular purpose (including, but not limited to, use in life support applications, where malfunctions of product can cause injury to a person's health or life).

### © Flex 2020

The information and specifications in this technical specification is believed to be correct at the time of publication. However, no liability is accepted for inaccuracies, printing errors or for any consequences thereof. Flex reserves the right to change the contents of this technical specification at any time without prior notice.

## Technical Specification

**BMR490 series** Non-isolated DC-DC Converters  
Input 40-60 V, Output up to 139 A / 1300 W

28701-BMR490 Rev D

September 2020

© Flex

**Safety Specification****General information**

Flex Power Modules DC/DC converters and DC/DC regulators are designed in accordance with the safety standards IEC 60950-1, EN 60950-1 and UL 60950-1 *Safety of Information Technology Equipment*.

IEC/EN/UL 60950-1 contains requirements to prevent injury or damage due to the following hazards:

- Electrical shock
- Energy hazards
- Fire
- Mechanical and heat hazards
- Radiation hazards
- Chemical hazards

On-board DC/DC converters and DC/DC regulators are defined as component power supplies. As components they cannot fully comply with the provisions of any safety requirements without “conditions of acceptability”. Clearance between conductors and between conductive parts of the component power supply and conductors on the board in the final product must meet the applicable safety requirements. Certain conditions of acceptability apply for component power supplies with limited stand-off (see Mechanical Information and Safety Certificate for further information). It is the responsibility of the installer to ensure that the final product housing these components complies with the requirements of all applicable safety standards and regulations for the final product.

Component power supplies for general use should comply with the requirements in IEC/EN/UL 60950-1 *Safety of Information Technology Equipment*. Product related standards, e.g. IEEE 802.3af *Power over Ethernet*, and ETS-300132-2 *Power interface at the input to telecom equipment, operated by direct current (dc)* are based on IEC/EN/UL 60950-1 with regards to safety.

Flex Power Modules DC/DC converters, Power interface modules and DC/DC regulators are UL 60950-1 recognized and certified in accordance with EN 60950-1. The flammability rating for all construction parts of the products meet requirements for V-0 class material according to IEC 60695-11-10, *Fire hazard testing, test flames – 50 W* horizontal and vertical flame test methods.

**Isolated DC/DC converters**

The product may provide basic or functional insulation between input and output according to IEC/EN/UL 60950-1 (see Safety Certificate), different conditions shall be met if the output of a basic or a functional insulated product shall be considered as safety extra low voltage (SELV).

For basic insulated products (see Safety Certificate) the output is considered as safety extra low voltage (SELV) if

one of the following conditions is met:

- The input source provides supplementary or double or reinforced insulation from the AC mains according to IEC/EN/UL 60950-1.
- The input source provides functional or basic insulation from the AC mains and the product’s output is reliably connected to protective earth according to IEC/EN/UL 60950-1.

For functional insulated products (see Safety Certificate) the output is considered as safety extra low voltage (SELV) if one of the following conditions is met:

- The input source provides double or reinforced insulation from the AC mains according to IEC/EN/UL 60950-1.
- The input source provides basic or supplementary insulation from the AC mains and the product’s output is reliably connected to protective earth according to IEC/EN/UL 60950-1.
- The input source is reliably connected to protective earth and provides basic or supplementary insulation according to IEC/EN/UL 60950-1 and the maximum input source voltage is 60 Vdc.

Galvanic isolation between input and output is verified in an electric strength test and the isolation voltage ( $V_{iso}$ ) meets the voltage strength requirement for basic insulation according to IEC/EN/UL 60950-1.

It is recommended to use a slow blow fuse at the input of each DC/DC converter. If an input filter is used in the circuit the fuse should be placed in front of the input filter. In the rare event of a component problem that imposes a short circuit on the input source, this fuse will provide the following functions:

- Isolate the fault from the input power source so as not to affect the operation of other parts of the system
- Protect the distribution wiring from excessive current and power loss thus preventing hazardous overheating

Technical Specification

**BMR490 series** Non-isolated DC-DC Converters  
 Input 40-60 V, Output up to 139 A / 1300 W

28701-BMR490 Rev D      September 2020  
 © Flex

**Absolute Maximum Ratings**

Characteristics		min	typ	max	Unit
$T_{P1}$	Operating Temperature (see Thermal Consideration section)	-40		+125	°C
$T_s$	Storage temperature	-55		+125	°C
$V_I$	Input voltage	-0.5		+65	V
$V_{iso}$	Isolation voltage (input to output test voltage)			0	Vdc
$V_{iso}$	Isolation voltage (base plate to output test voltage)			0	Vdc
$V_{tr}$	Input voltage transient ( $t_p$ 100 ms)			+80	V
$V_{RC}$	Remote Control pin voltage	-0.3		5	V

Stress in excess of Absolute Maximum Ratings may cause permanent damage. Absolute Maximum Ratings, sometimes referred to as no destruction limits, are normally tested with one parameter at a time exceeding the limits in the Electrical Specification. If exposed to stress above these limits, function and performance may degrade in an unspecified manner.

**Fundamental Circuit Diagram**

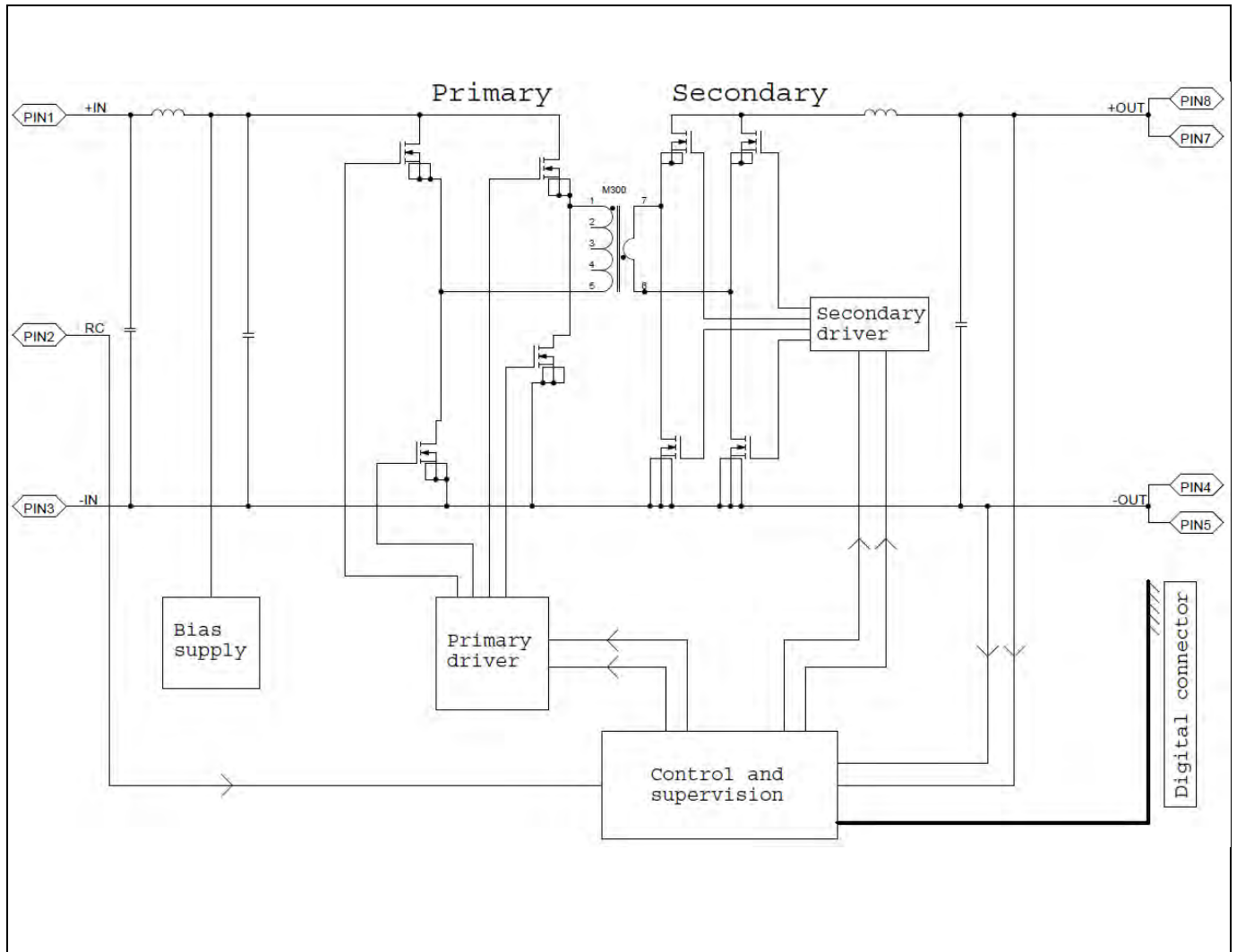

## Technical Specification

<b>BMR490 series</b> Non-isolated DC-DC Converters Input 40-60 V, Output up to 139 A / 1300 W	28701-BMR490 Rev D	September 2020
	© Flex	

**Common Electrical Specification**

This section includes parameter specifications common to all product versions within the product series. Typically, these are parameters defined by the digital controller of the products. In the table below PMBus commands for configurable parameters are written in capital letters.

$T_{P1} = -30$  to  $+95$  °C,  $V_I = 40$  to  $60$  V, unless otherwise specified under Conditions.

Typical values given at:  $T_{P1} = +25$  °C,  $V_I = 53$  V, max  $I_O$ , unless otherwise specified under Conditions:

BMR490XXXX/820 (Stand-alone)

Characteristics		Conditions	min	typ	max	Unit
$f_{SW} = 1/T_{SW}$	Switching Frequency			180		kHz
	Switching Frequency Range, Note 1	PMBus configurable FREQUENCY_SWITCH	150		195	kHz
	Switching Frequency Set-point Accuracy	$T_{P1} = +25$ °C	-2		2	%
	External Sync Pulse Width		150			ns
	Input Clock Frequency Drift Tolerance	External sync	-4		4	%

$T_{INIT}$	Initialization Time	From $V_I > \sim 27$ V to ready to be enabled		30		ms
$T_{ONdel\_tot}$	Output voltage Total On Delay Time	Enable by input voltage		$T_{INIT} + T_{ONdel}$		
		Enable by RC or CTRL pin		$T_{ONdel}$		
$T_{ONdel}$	Output voltage On Delay Time	PMBus configurable Turn on delay duration		0		ms
		Range TON_DELAY	0		655	ms
		Accuracy (actual delay vs set value)		$\pm 1$		%
$T_{OFFdel}$	Output voltage Off Delay Time	PMBus configurable Turn off delay duration, Note 2		5		ms
		Range TOFF_DELAY	0		655	ms
		Accuracy (actual delay vs set value), Note 3		$\pm 1$		%
$T_{ONrise} / T_{OFFfall}$	Output voltage On/Off Ramp Time (0-100%-0 of $V_O$ )	Turn on ramp duration		10		ms
		Turn off ramp duration	Disabled in standard configuration. Turn off immediately upon expiration of Turn off delay.			
		Range TON_RISE/TOFF_FALL	0		655	ms
		Ramp time accuracy for standalone operation (actual ramp time vs set value)		$\pm 1$		%
$V_{loff}$	Input turn off range	States the level where the output voltage is disabled, PMBus configurable	30	35	60	V
$V_{lon}$	Input turn on range	States the level where the output voltage is enabled, PMBus configurable.	30	37	60	V

Technical Specification

<b>BMR490 series</b> Non-isolated DC-DC Converters Input 40-60 V, Output up to 139 A / 1300 W	28701-BMR490 Rev D	September 2020
	© Flex	

Characteristics		Conditions	min	typ	max	Unit
Input Under Voltage Protection, IUVP	IUVP threshold	PMBus configurable		0		V
	IUVP threshold range	VIN_UV_FAULT_LIMIT		0-100		%VIN
	IUVP hysteresis	PMBus configurable		0		V
	IUVP hysteresis range	VIN_UV_FAULT_LIMIT- VIN_UV_WARN_LIMIT		0		V
	Set point accuracy			1		%
	IUVP response delay			100		µs
	Fault response	PMBus configurable VIN_UV_FAULT_RESPONSE	Ignore fault			
Input Over Voltage Protection, IOVP	IOVP threshold	PMBus configurable		85		V
	IOVP threshold range	VIN_OV_FAULT_LIMIT		0-100		%VIN
	IOVP hysteresis	PMBus configurable VIN_OV_FAULT_LIMIT- VIN_OV_WARN_LIMIT		0		V
	IOVP hysteresis range	VIN_OV_WARN_LIMIT		0-100		%VIN
	Set point accuracy			±1		%
	IOVP response delay			100		µs
	Fault response	PMBus configurable VIN_OV_FAULT_RESPONSE	Disable until Fault Cleared			
Output Voltage Over/Under Voltage Protection, OVP/UVP	UVP threshold	PMBus configurable		0		VO
	UVP threshold range	VO_UV_FAULT_LIMIT		0-100		%VO
	OVP threshold	PMBus configurable		15.6		VO
	OVP threshold range	VO_UV_FAULT_LIMIT		0-16		VO
	UVP/OVP response time			100/50		µs
	Fault response	PMBus configurable VO_UV_FAULT_RESPONSE	Ignore fault			
		PMBus configurable VO_OV_FAULT_RESPONSE	Disable and retry, retry 3 times, 1s delay.			
Over Current Protection, OCP Note 5	OCP threshold	PMBus configurable		150		A
	OCP threshold range	IOUT_OC_FAULT_LIMIT		0-256		A
	Protection delay	See Note 4		0		ms
	Fault response	PMBus configurable MFR_IOUT_OC_FAULT_RESPONSE -Stand alone, see Note 6 -DLS	Disable and retry, retry 3 times, 1s delay.			
Over Temperature Protection, OTP, Note 7	OTP threshold	PMBus configurable		125		°C
	OTP threshold range	OT_FAULT_LIMIT	-50		+150	°C
	OTP hysteresis	PMBus configurable OT_FAULT_LIMIT- OT_WARN_LIMIT		35		°C
	Fault response	PMBus configurable OT_FAULT_RESPONSE	Shutdown, automatic restart when no fault exists, ~90°C @ the temperature sensor			

## Technical Specification

**BMR490 series** Non-isolated DC-DC Converters  
Input 40-60 V, Output up to 139 A / 1300 W

28701-BMR490 Rev D September 2020  
© Flex

Characteristics		Conditions	min	typ	max	Unit
Monitoring Accuracy	Input voltage READ_VIN			±125		mV
	Output voltage READ_VOUT			±10		mV
	Output current READ_IOUT	$T_{P1} = 25\text{ °C}, V_O = 12.0\text{ V}$		±0.25		A
		$T_{P1} = -30 - 125\text{ °C}, V_O = 12.0\text{ V}$		±2.5		A
	Duty cycle READ_DUTY_CYCLE		No tolerance, Read value is the actual value applied by PWM controller			
Temperature READ_TEMPERATURE_1	Temperature sensor, -30 - 125 °C		±7		°C	

$V_{OL}$	Logic output low signal level	SCL, SDA, SYNC, GCB, SALERT, PG Sink /source current = 4 mA		0.25	V	
$V_{OH}$	Logic output high signal level		2.7		V	
$I_{OL}$	Logic output low sink current			4	mA	
$I_{OH}$	Logic output high source current			4	mA	
$V_{IL}$	Logic input low threshold	SCL, SDA, CTRL, SYNC		1.1	V	
$V_{IH}$	Logic input high threshold		2.1		V	
$C_{I\_PIN}$	Logic pin input capacitance	SCL, SDA, CTRL, SYNC		10	pF	
$f_{SMB}$	Supported SMBus Operating frequency		100	400	kHz	
$T_{BUF}$	SMBus Bus free time	STOP bit to START bit See section SMBus – Timing		1.3	µs	
$t_{set}$	SMBus SDA setup time from SCL	See section SMBus – Timing		100	ns	
$t_{hold}$	SMBus SDA hold time from SCL	See section SMBus – Timing		0	ns	
	SMBus START/STOP condition setup/hold time from SCL			600	ns	
$T_{low}$	SCL low period		1.3		µs	
$T_{high}$	SCL high period			0.6	50	µs

Note 1. There are configuration changes to consider when changing the switching frequency, see section Switching Frequency.

Note 2. A default value of 0 ms forces the device to Immediate Off behavior with TOFF\_FALL ramp-down setting being ignored.

Note 3. The specified accuracy applies for off delay times larger than 4 ms. When setting 0 ms the actual delay will be 0 ms.

Note 4. According to the combination of command MFR\_RESPONSE\_UNIT\_CFG and delay time set in IOUT\_OC\_FAULT\_RESPONSE, see Appendix – PMBus commands.

Note 5. Note that higher OCP threshold than specified may result in damage of the module at OC fault conditions.

Note 6. For current setting see Appendix – PMBus commands

Note 7. See section Over Temperature Protection (OTP).

## Technical Specification

<b>BMR490 series</b> Non-isolated DC-DC Converters Input 40-60 V, Output up to 139 A / 1300 W	28701-BMR490 Rev D	September 2020
	© Flex	

**BMR 490 3317/820**
**Electrical Specification**
**12 V, 139 A / 1300 W**
 $T_{P1} = -30$  to  $+95^{\circ}\text{C}$ ,  $V_I = 40$  to  $60$  V, unless otherwise specified under Conditions, see Note 2.

 Typical values given at:  $T_{P1} = +25^{\circ}\text{C}$ ,  $V_I = 54$  V, max  $P_O$ , unless otherwise specified under Conditions, see Note 1.

 Additional  $C_{out} = 3.56$  mF,  $C_{in} = 0.47$  mF

Characteristics		Conditions	min	typ	max	Unit
$V_I$	Input voltage range		40		60	V
$V_{loff}$	Turn-off input voltage	Decreasing input voltage	34	35	36	V
$V_{lon}$	Turn-on input voltage	Increasing input voltage	36	37	38	V
$C_I$	Internal input capacitance	$V_I = 54$ V		9.5		$\mu\text{F}$
$P_O$	Output power	See Note 1 & 2	0		1300	W
$\eta$	Efficiency	50% of max $P_O$		97.6		%
		max $P_O$		97.1		
		50% of max $P_O$ , $V_I = 51$ V		97.7		
		max $P_O$ , $V_I = 51$ V		97.2		
$P_d$	Power Dissipation	max $P_O$ , $V_I > 50.25$ V		38.1	54.3	W
$P_d$	Power Dissipation	max $P_O$ , $V_I = 40$ V		58.3	72.9	W
$P_{li}$	Input idling power	$P_O = 0$ A, $V_I = 54$ V		6.3		W
$P_{RC}$	Input standby power	$V_I = 54$ V (turned off with RC)		0.9		W
$f_s$	Switching frequency	0-100 % of max $P_O$	175	180	184	kHz

$V_{oi}$	Output voltage initial setting and accuracy	$T_{P1} = +25^{\circ}\text{C}$ , $V_I = 54$ V, $P_O = 0$ W	11.97	12	12.03	V
$V_O$	Output voltage tolerance band	0-100% of max $P_O$ , $V_I = 50.25 - 60$ V	11.76		12.24	V
	Low line input; output voltage tolerance band	0-100% of max $P_O$ $V_I = 40 - 50.25$ V, see Note 2	9.35		12.24	V
	Output adjust range	0-100% of max $P_O$ , see Note 2	8		12	V
	Idling voltage	$P_O = 0$ W	11.91		12.04	V
	Idling voltage	$P_O = 0$ W, 40 V	9.55		9.67	V
	Line regulation	$V_I = 50.25 - 60$ V, 100% of max $P_O$		6		mV
	Low input Line regulation	$V_I = 40 - 50.25$ V, 100% of max $P_O$ , See Note 2 regarding $V_O$		2380	2570	mV
	Load regulation	$V_I = 54$ V, 0-100% of max $P_O$		11		mV
$V_{tr}$	Load transient voltage deviation	$V_I = 54$ V, Load step 25-75-25% of max $P_O$ , $di/dt = 2$ A/ $\mu\text{s}$ .		$\pm 440$		mV
$t_{tr}$	Load transient recovery time	See Note 3		200		$\mu\text{s}$
$t_r$	Ramp-up time (from 0-100% of $V_{oi}$ )	0-100% of max $P_O$		10		ms
$t_s$	Start-up time (from $V_I$ connection to 90% of $V_{oi}$ )			40		ms
$t_{RC}$	RC start-up time	max $P_O$		11		ms
$I_O$	Output current	$V_I = 40 - 60$ V, see Note 1	0		139	A
$I_{lim}$	Current limit threshold	$T_{P1} < \max T_{P1}$	140	150	160	A
$I_{sc}$	Short circuit current	$T_{P1} = 25^{\circ}\text{C}$ , $I_{rms}$ , see Note 4		24		A
$V_{Oac}$	Output ripple & noise	See ripple & noise section, max $P_O$		46		mVp-p
OVP	Output over voltage protection			15.6		V

Note 1: The maximum output current is limited to 139A, the maximum power is limited to 1300W

 Note 2: Below HRR (Hybrid Regulated Ratio) set point the output voltage will track the input voltage but include a guard band to ensure enough head room to max duty cycle in order to secure full regulation down to  $V_{IN\_OFF}$  at maximum output current. Resulting  $V_{out}$  can be derived by using the formulae: if  $V_{in} < V_{in\_knee} = V_{O} - (V_{iknee} - V_I) / 4$  else  $V_O = V_{oi}$ . The maximum available output power will be below 46Vin, when operating in HRR, be time restricted due to output voltage input voltage dependency. See graph below.

 Note 3:  $C_{out} = 3.56$  mF (7x470  $\mu\text{F} + 270$   $\mu\text{F}$ ; 16SEPC, Panasonic, low ESR, POLYMER cap.)

Note 4: Hiccup short circuit protection; RMS output current is the presented.



**BMR490 series** Non-isolated DC-DC Converters  
Input 40-60 V, Output up to 139 A / 1300 W

28701-BMR490 Rev D September 2020  
© Flex

**Typical Characteristics**  
**12 V / 1300 W**

**BMR 490 3317/820**

**Efficiency**

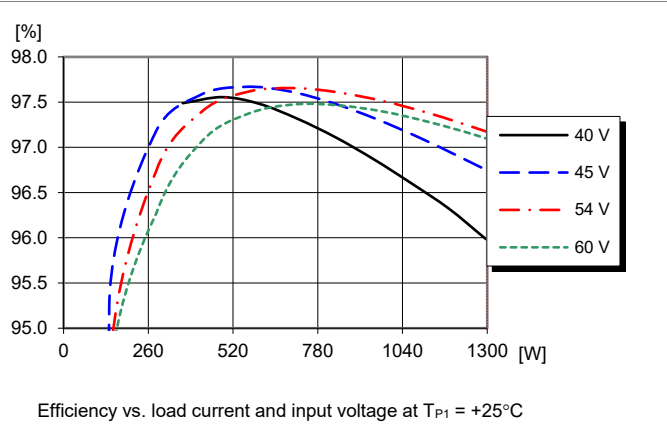

**Power Dissipation**

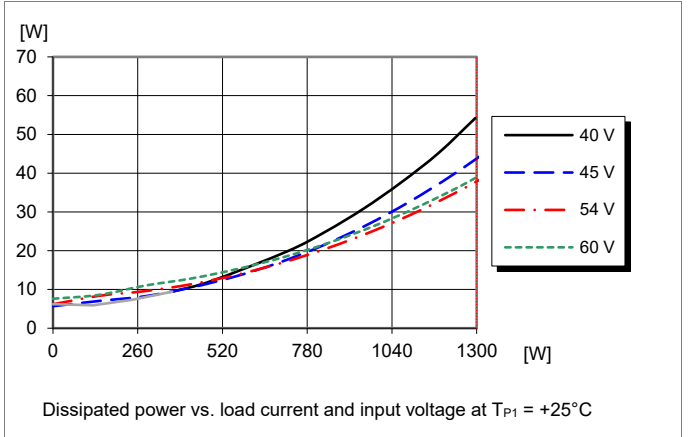

**Output Power Derating – Baseplate only – 54Vin**

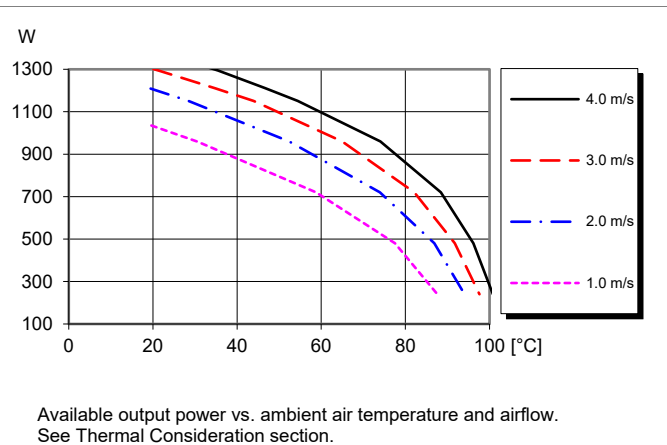

**Output Power Derating – 1" Heat Sink – 54Vin**

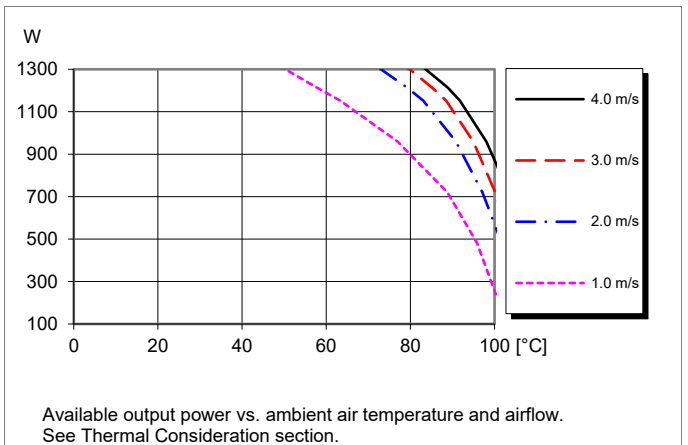

**Line Characteristics – typical**

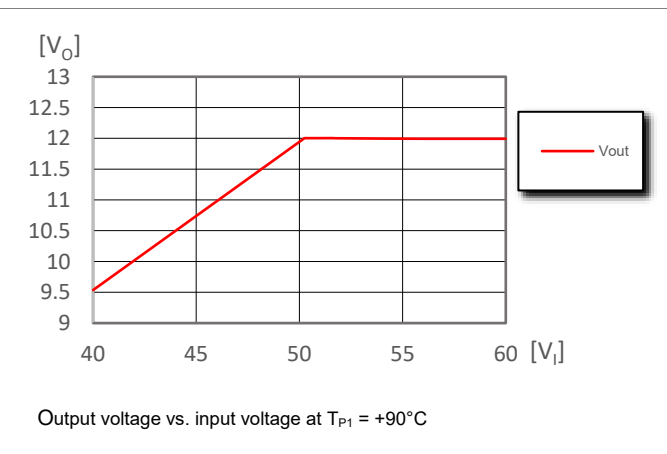

**Available Power**

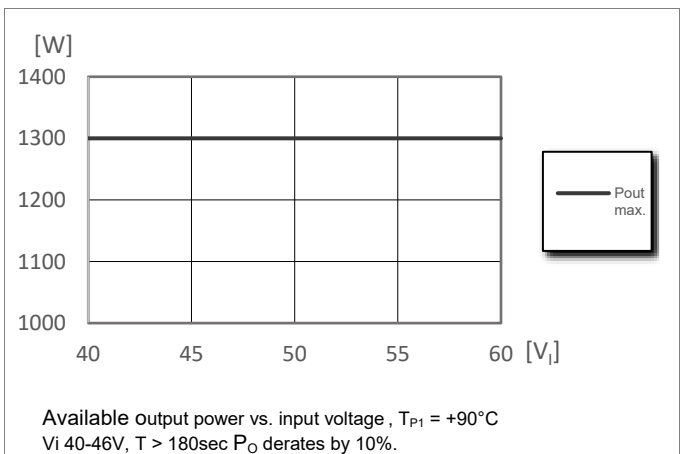

Technical Specification

**BMR490 series** Non-isolated DC-DC Converters  
 Input 40-60 V, Output up to 139 A / 1300 W

28701-BMR490 Rev D September 2020  
 © Flex

**Typical Characteristics**  
**12 V / 1300 W**

**BMR 490 3317/820**

**Start-up**

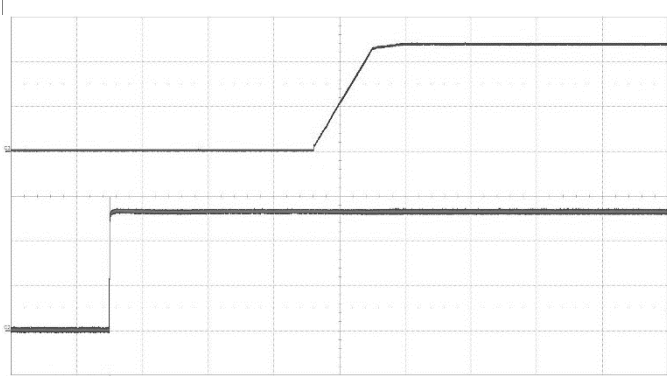

Start-up enabled by connecting  $V_i$  at:  
 $T_{PI} = +25^\circ\text{C}$ ,  $V_i = 54\text{ V}$ ,  
 $I_o = 108.3\text{ A}$  constant resistance.

Top trace: output voltage 5 V/div.  
 Bottom trace: input voltage 50 V/div.  
 Time scale: 10 ms/div

**Shut-down**

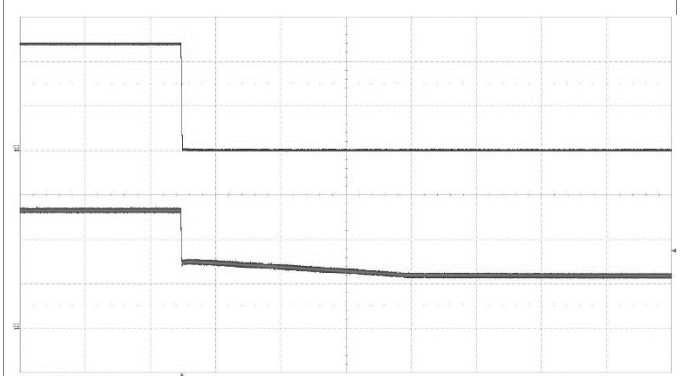

Shut-down enabled by disconnecting  $V_i$  at:  
 $T_{PI} = +25^\circ\text{C}$ ,  $V_i = 54\text{ V}$ ,  
 $I_o = 108.3\text{ A}$  resistive load + CR.

Top trace: div output voltage 5 V/div.  
 Bottom trace: input voltage 20 V/div.  
 Time scale: 50 ms/div.

**Output Ripple & Noise**

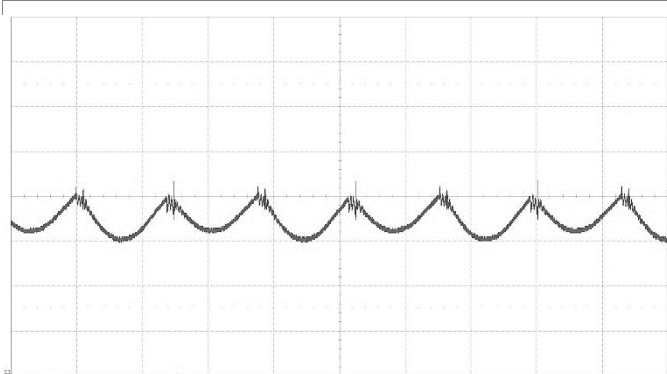

Output voltage ripple at:  
 $T_{PI} = +25^\circ\text{C}$ ,  $V_i = 54\text{ V}$ ,  
 $I_o = 108.3\text{ A}$  constant resistance.

Trace: output voltage 20 mV/div.  
 Time scale: 2  $\mu\text{s}$ /div.  
 Probe BW set to 20 MHz

**Output Load Transient Response**



Output voltage response to load current step-  
 change 27-81-27 A (2 A/ $\mu\text{s}$ ) at:  
 $T_{PI} = +25^\circ\text{C}$ ,  $V_i = 54\text{ V}$ .

Top trace: load current 50 A/div.  
 Bottom trace: output voltage 500 mV/div.  
 Time scale: 0.5 ms/div.

Technical Specification

**BMR490 series** Non-isolated DC-DC Converters  
Input 40-60 V, Output up to 139 A / 1300 W

28701-BMR490 Rev D September 2020  
© Flex

**EMC Specification**

Conducted EMI measured according to EN55022 / EN55032, CISPR 22 / CISPR 32 and FCC part 15J (see test set-up). The fundamental switching frequency is 180 kHz for BMR490. The EMI characteristics below is measured at  $V_i = 53$  V and max  $I_o$ .

**Conducted EMI Input terminal value (typ)**

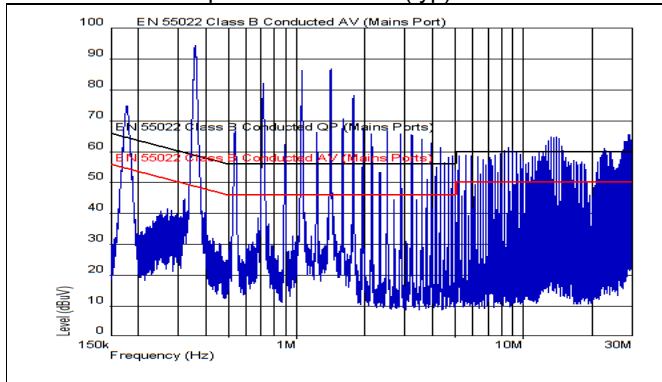

EMI without filter. EN55032 Test method and limits are the same as EN55022. 470  $\mu$ F 100V input capacitor and 470  $\mu$ F 16 V OS-CON output capacitor used.

**Optional external filter for class B**

Suggested external input filter in order to meet class B in EN 55022 / EN 55032, CISPR 22 / CISPR 32 and FCC part 15J.

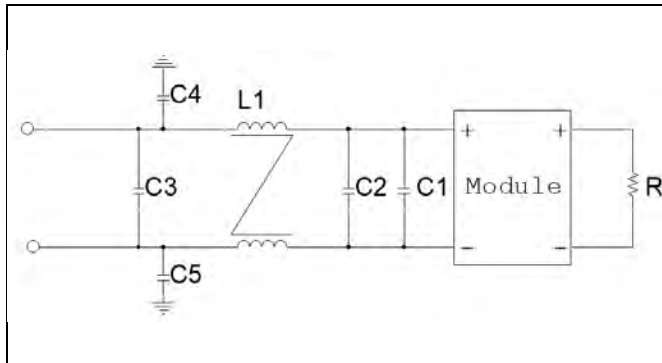

Filter components:  
C1 = 2 x 4.7  $\mu$ F MLCC      L1 = 2 mH  
C2 = 470  $\mu$ F (e-lyt)      C4, C5 = 3.3 nF MLCC  
C3 = 470  $\mu$ F (e-lyt)

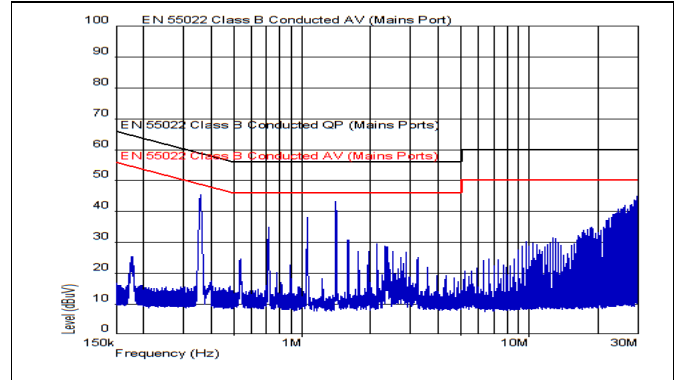

EMI with filter, EN55022 Test method and limits are the same as EN55032.

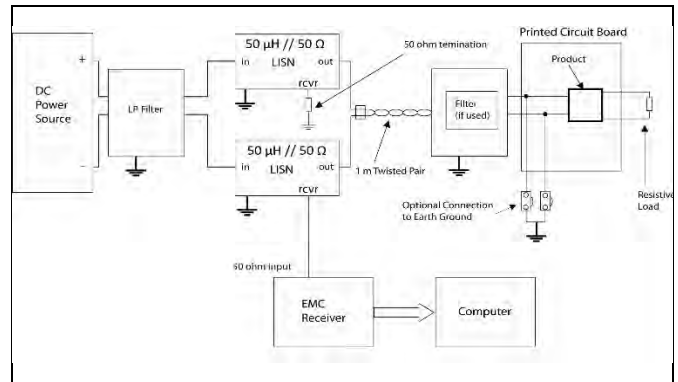

Test set-up.

**Layout recommendations**

The radiated EMI performance of the product will depend on the PWB layout and ground layer design. It is also important to consider the stand-off of the product. If a ground layer is used, it should be connected to the output of the product and the equipment ground or chassis.

A ground layer will increase the stray capacitance in the PWB and improve the high frequency EMC performance.

**Output ripple and noise**

Output ripple and noise measured according to figure below. See Design Note 022 for detailed information.

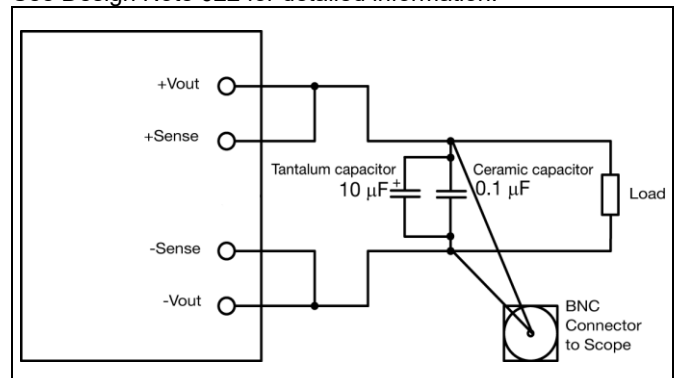

Output ripple and noise test setup

Technical Specification

**BMR490 series** Non-isolated DC-DC Converters  
Input 40-60 V, Output up to 139 A / 1300 W

28701-BMR490 Rev D September 2020  
© Flex

**Power Management Overview**

This product is equipped with a PMBus interface. The product incorporates a wide range of readable and configurable power management features that are simple to implement with a minimum of external components. Additionally, the product includes protection features that continuously safeguard the load from damage due to unexpected system faults. A fault is also shown as an alert on the SALERT pin. The following product parameters can continuously be monitored by a host: Input voltage, output voltage/current, duty cycle and internal temperature.

The product is delivered with a default configuration suitable for a wide range operation in terms of input voltage, output voltage, and load. The configuration is stored in an internal Non-Volatile Memory (NVM). All power management functions can be reconfigured using the PMBus interface

Throughout this document, different PMBus commands are referenced. A detailed description of each command is provided in the appendix at the end of this specification.

The Flex Power Designer software suite can be used to configure and monitor this product via the PMBus interface. For more information please contact your local Flex sales representative.

**SMBus Interface**

This product provides a PMBus digital interface that enables the user to configure many aspects of the device operation as well as to monitor the input and output voltages, output current and device temperature. The product can be used with any standard two-wire I<sup>2</sup>C (master must allow for clock stretching) or SMBus host device. In addition, the product is compatible with PMBus version 1.3 and includes an SALERT line to help mitigate bandwidth limitations related to continuous fault monitoring. The product supports 100 kHz and 400 kHz bus clock frequency only. The PMBus signals, SCL, SDA and SALERT require passive pull-up resistors as stated in the SMBus Specification. Pull-up resistors are required to guarantee the rise time as follows:

$$\text{Eq. 7} \quad \tau = R_p C_p \leq 1\mu s$$

where  $R_p$  is the pull-up resistor value and  $C_p$  is the bus load. The maximum allowed bus load is 400 pF. The pull-up resistor should be tied to an external supply between 2.7 to 3.8 V, which should be present prior to or during power-up. If the proper power supply is not available, voltage dividers may be applied. Note that in this case, the resistance in the equation above corresponds to parallel connection of the resistors forming the voltage divider.

It is recommended to always use PEC (Packet Error Check) when communicating via PMBus. There is an optional setting that makes PEC required which further increase communication robustness. This can be configured by setting bit 7 in command MFR\_SPECIAL\_OPTIONS (0xE0).

**PMBus Addressing**

The following figure and table show recommended resistor values with min and max voltage range for hard-wiring PMBus addresses (series E96, 1% tolerance resistors suggested):

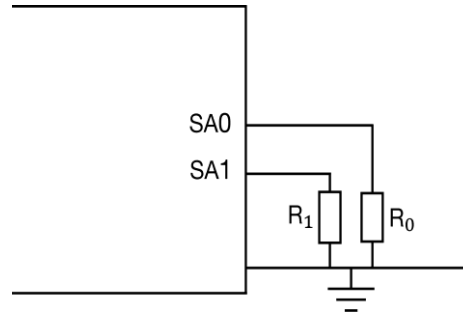

Schematic of connection of address resistors, (SA0 is not used for variants with the 4 pin digital header variant)

SA1 Index	R <sub>SA1</sub> [kΩ]	Resulting address with MFR_OFFSET_ADDRESS = 96d
0	10	96d (0x60)
1	15	97d (0x61)
2	21	98d (0x62)
3	28	99d (0x63)
4	35.7	100d (0x64)
5	45.3	101d (0x65)
6	56.2	102d (0x66)
7	69.8	103d (0x67)
8	88.7	104d (0x68)
9	107	105d (0x69)
10	130	106d (0x6A)
11	158	107d (0x6B)
12	191	108d (0x6C)
13	232	109d (0x6D)

The SA1 pin can be configured with a resistor to GND according to the following equation.

$$\text{PMBus Address(decimal)} = \text{SA1 index} + \text{MFR\_OFFSET\_ADDRESS}$$

If the calculated PMBus address is 0, 11 or 12, PMBus address 127 is assigned instead. From a system point of view, the user shall also be aware of further limitations of the addresses as stated in the PMBus Specification. It is not recommended to keep the SA1 pin left open. See section MFR\_OFFSET\_ADDRESS (0xEE) how to set the command to utilize single address pin option. Specific variants may already have a default non-zero value set for MFR\_OFFSET\_ADDRESS.

**BMR490 series** Non-isolated DC-DC Converters  
Input 40-60 V, Output up to 139 A / 1300 W

28701-BMR490 Rev D September 2020

© Flex

**I<sup>2</sup>C/SMBus – Timing**

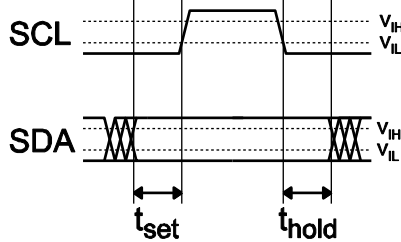

Setup and hold times timing diagram

The setup time,  $t_{set}$ , is the time data, SDA, must be stable before the rising edge of the clock signal, SCL. The hold time  $t_{hold}$ , is the time data, SDA, must be stable after the rising edge of the clock signal, SCL. If these times are violated incorrect data may be captured or meta-stability may occur and the bus communication may fail. All standard SMBus protocols must be followed, including clock stretching. This product supports the BUSY flag in the status commands to indicate product being too busy for SMBus response. A bus-free time delay between every SMBus transmission (between every stop & start condition) must occur. Refer to the SMBus specification, for SMBus electrical and timing requirements. Note that an additional delay of 5 ms has to be inserted in case of storing the RAM content into the internal non-volatile memory.

**Monitoring via PMBus**

It is possible to continuously monitor a wide variety of parameters through the PMBus interface. These include, but are not limited to, the parameters listed in the table below.

Parameter	PMBus Command
Input voltage	READ_VIN
Output voltage	READ_VOUT
Output current	READ_IOUT
Temperature *	READ_TEMPERATURE_1
Switching Frequency	READ_FREQUENCY
Duty cycle	READ_DUTY_CYCLE

\*Reports the temperature from temperature sensor set in command 0xDC, internal (controller IC)/external (temp sensor).

**Monitoring Faults**

Fault conditions can be detected using the SALERT pin, which will be asserted low when any number of pre-configured fault or warning conditions occurs. The SALERT pin will be held low until faults and/or warnings are cleared by the CLEAR\_FAULTS command, or until the output voltage has been re-enabled. It is possible to mask which fault conditions should not assert the SALERT pin by the command SMBALERT\_MASK. In response to the SALERT signal, the user may read a number of status commands to find out what fault or warning condition occurred, see table below.

Fault & Warning Status	PMBus Command
Overview, Power Good	STATUS_BYTE STATUS_WORD
Output voltage level	STATUS_VOUT
Output current level	STATUS_IOUT
Input voltage level	STATUS_INPUT
Temperature level	STATUS_TEMPERATURE
PMBus communication	STATUS_CML
Miscellaneous	STATUS_MFR_SPECIFIC

**Snapshot Parameter Capture**

When input voltage disappears during conversion the Snapshot functionality will automatically store parametric RAM data to NVM. After one successful ramp with  $V_{in}$  still in the operating range, the snap shot data contains only FFh. To be able to retrieve snap shot data from the previous power cycle, it is therefore important to eliminate ramp up e.g by turning RC off or keeping  $V_{in}$  at 30V. The NVM data can be read back using the MFR\_GET\_SNAPSHOT (0xD7) command to provide valuable information for analysis. The snap shot parameters called old are the recorded values at the fault event. All other snap shot parameters are stored to NVM when  $V_i$  falls below  $V_{loff}$  level. Theoretically the snapshot could be corrupted by a very fast  $V_{in}$  drop. Following parameters are stored to NVM:

- Input voltage old
- Output voltage old
- Output current old
- Duty cycle old
- Input voltage
- Output voltage
- Output current
- Temperature\_1 (sensor select in 0xDC)
- Temperature\_2
- Time in operation
- Status\_word
- Status\_byte
- Status\_Vout
- Status\_Iout
- Status\_Temperature
- Status\_CML
- Status\_Other
- Status\_MFR\_Specific
- Snap shot cycles

Read MFR\_GET\_SNAPSHOT using the Flex Power Designer.

**Ramp up data Capture**

The command MFR\_GET\_RAMP\_DATA (0xDB) retrieves 32 bytes of ramp data. 15 pairs of instant values of  $V_{in}$  and  $V_{out}$  are recorded during ramp and the interval is adjusted to the ramp time. Data byte 1 & 2 is the counter. Instant values of  $V_{in}$  &  $V_{out}$  are recorded as 8-bit integers, data byte 3 is the first  $V_{in}$  sample and data byte 4 is the first  $V_{out}$  sample.  $V_{in}$  &  $V_{out}$  are recorded as pairs until the ramp is finished. The

## Technical Specification

**BMR490 series Non-isolated DC-DC Converters**  
Input 40-60 V, Output up to 139 A / 1300 W

28701-BMR490 Rev D

September 2020

© Flex

record counter value is recorded just before ramp. The record value is equal to last value of “snap shot cycles” + 1. This way it can be judged whether the ramp data was recorded before or after snap shot data. Only the first ramp in a power cycle will be recorded. If the read out of the 32 bytes are all FFh then it is a successful ramp-up. Only the first ramp in a power cycle will be recorded. Thus, if the ramp fails, consequent ramp attempts will not be recorded and bit 6 in STATUS\_MFR\_SPECIFIC (0x80) will be set. Read MFR\_GET\_RAMP\_DATA (0xDB) using Flex Power Designer.

#### Status data Capture

The command MFR\_GET\_STATUS\_DATA (0xDF) retrieves 32 bytes consisting of a power cycle counter and 15 status words. The recording starts just after ramp has finished. Firstly, the power cycle counter is retrieved from the ramp data and stored as the first word. Secondly the status word is stored. The unit then continues to store status words every ~8 sec intervals. Total recording time is  $\sim 8 * 15 \sim 120$  s.

#### Non-Volatile Memory (NVM)

The product incorporates two Non-Volatile Memory areas for storage of the PMBus command values; the Default NVM and the User NVM. The Default NVM is pre-loaded with Flex factory default values. The Default NVM is write-protected and can be used to restore the Flex factory default values through the command RESTORE\_DEFAULT\_ALL (0x12). The User NVM is pre-loaded with Flex factory default values. The User NVM is writable and open for customization. The values in NVM are loaded during initialization according to section Initialization Procedure, where after commands can be changed through the PMBus Interface. The STORE\_USER\_ALL (0x15) command will store the changed parameters to the User NVM.

#### Operating Information

##### Input Voltage

The input voltage range 40 to 60 Vdc meets the requirements for normal input voltage range in -48 Vdc systems, -40.5 to -57.0 V. At input voltages exceeding 60 V, the power loss will be higher than at normal input voltage and  $T_{P1}$  must be limited to absolute max +125°C. The absolute maximum continuous input voltage is 65 Vdc.

Short duration transient disturbances can occur on the DC distribution and input of the product when a short circuit fault occurs on the equipment side of a protective device (fuse or circuit breaker). The voltage level, duration and energy of the disturbance are dependent on the particular DC distribution network characteristics and can be sufficient to damage the product unless measures are taken to suppress or absorb this energy. The transient voltage can be limited by capacitors and other energy absorbing devices like zener diodes connected across the positive and negative input conductors at a number of strategic points in the distribution network. The end-user must secure that the transient voltage will not exceed the value stated in the Absolute maximum ratings. ETSI TR 100 283 examines the parameters of DC distribution networks

and provides guidelines for controlling the transient and reduce its harmful effect.

#### Turn-on and -off Input Voltage

The product monitors the input voltage and will turn on and turn off at configured thresholds (see Electrical Specification). The turn-on input voltage threshold is set higher than the corresponding turn-off threshold. Hence, there is a hysteresis between turn-on and turn-off input voltage levels.

#### Remote Control (RC)

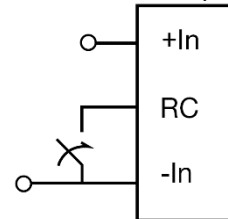

The products are fitted with a remote control function referenced to the primary negative input connection (-In), with negative and positive logic options available. The RC function allows the product to be turned on/off by an external device like a semiconductor or mechanical switch.

The RC pin has an internal pull up resistor.

The external device must provide a minimum required sink current  $>0.5$  mA to guarantee a voltage not higher than maximum voltage on the RC pin (see Electrical characteristics table). When the RC pin is left open, the voltage generated on the RC pin is max 5 V. The standard product is provided with “negative logic” RC and will be off until the RC pin is connected to the -In. To turn off the product the RC pin should be left open. In situations where it is desired to have the product to power up automatically without the need for control signals or a switch, the RC pin shall be wired directly to -In.

#### Remote Control (secondary side)

The CTRL-pin can be configured as remote control via the PMBus interface. In the default configuration the CTRL-pin is disabled and floating. The output can be configured to internal pull-up to 3.3 V using the MFR\_MULTI\_PIN\_CONFIG (0xF9) command. The logic options for the secondary remote control can be positive or negative logic. The logic option for the secondary remote control is easily configured via ON\_OFF\_CONFIG (0x02) using Flex Power Designer software command, see also MFR\_MULTI\_PIN\_CONFIG section. When not used it is recommended to connect the CTRL pin to DGND.

#### Input and Output Impedance

The impedance of both the input source and the load will interact with the impedance of the product. It is important that the input source has low characteristic impedance. Minimum recommended external input capacitance is 220  $\mu$ F. The electrolytic capacitors will be degraded in low temperature. The needed input capacitance in low temperature should be equivalent to 220  $\mu$ F at 20°C. The performance in some applications can be enhanced by addition of external capacitance as described under External Decoupling Capacitors. If the input voltage source contains significant inductance, the addition of a low ESR ceramic capacitor of 22

## Technical Specification

**BMR490 series Non-isolated DC-DC Converters**  
Input 40-60 V, Output up to 139 A / 1300 W

28701-BMR490 Rev D

September 2020

© Flex

– 100  $\mu$ F capacitor across the input of the product will ensure stable operation. The minimum required capacitance value depends on the output power and the input voltage. The higher output power the higher input capacitance is needed.

### External Decoupling Capacitors

When powering loads with significant dynamic current requirements, the voltage regulation at the point of load can be improved by addition of decoupling capacitors at the load. The most effective technique is to locate low ESR ceramic and electrolytic capacitors as close to the load as possible, using several parallel capacitors to lower the effective ESR. The ceramic capacitors will handle high-frequency dynamic load changes while the electrolytic capacitors are used to handle low frequency dynamic load changes. It is equally important to use low resistance and low inductance PWB layouts and cabling.

External decoupling capacitors will become part of the product's control loop. The control loop is optimized for a wide range of external capacitance and the maximum recommended value that could be used without any additional analysis is found in the Electrical specification.

The ESR of the capacitors is a very important parameter. Stable operation is guaranteed with a verified ESR value of  $>1$  m $\Omega$  across the output connections.

For further information please contact your local Flex Power Modules representative.

### PMBus configuration and support

The product provides a PMBus digital interface that enables the user to configure many aspects of the device operation as well as monitor the input and output parameters.

The Flex Power Designer software suite can be used to configure and monitor this product via the PMBus interface. For more information, please contact your local Flex sales representative.

### Output Voltage Adjust using PMBus

The output voltage of the product can be reconfigured via PMBus command VOUT\_COMMAND (0x21) or VOUT\_TRIM (0x22). This can be used when adjusting the output voltage above or below output voltage initial setting up to a certain level, see Electrical specification for adjustment range.

When increasing the output voltage, the voltage at the output pins must be kept within the plotted area, see graph. Output voltage setting must be kept below the threshold of the over voltage protection, (OVP) to prevent the product from shutting down. At increased output voltages the maximum power rating of the product remains the same, and the max output current must be decreased correspondingly. According to below graph the BMR490 is operating at max duty cycle where the output voltage start to droop.

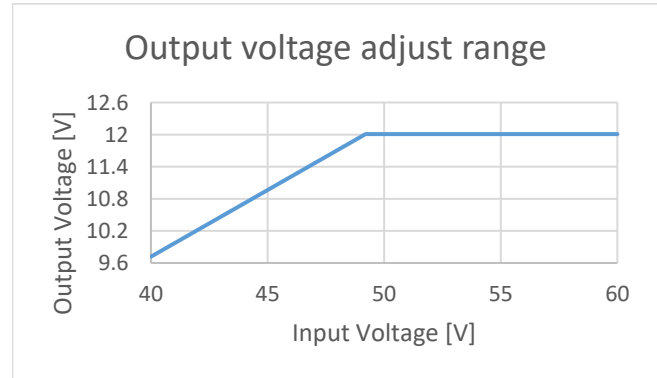

### HRR (Hybrid Regulated Ratio)

The main purpose of introducing HRR function is to support a regulated output which leave a headroom to 100% duty cycle. At a predetermined threshold configured via command VIN\_UV\_WARN\_LIMIT (0x58) the output voltage will follow the ratio of the input voltage. HRR operation is enabled by setting bit 6 in PMBus command MFR\_SPECIAL\_OPTION (0xE0). It is not recommended to use HRR functionality for devices operating in parallel configuration Droop load share (DLS) or Active Current Share (aCS) where the current share accuracy can't be fulfilled. The graph below shows one example with VIN\_UV\_WARN\_LIMIT set to 50.25V and HRR enabled.

The HRR operation is easily configured using Flex Power Designer software, see also Appendix – PMBus commands.

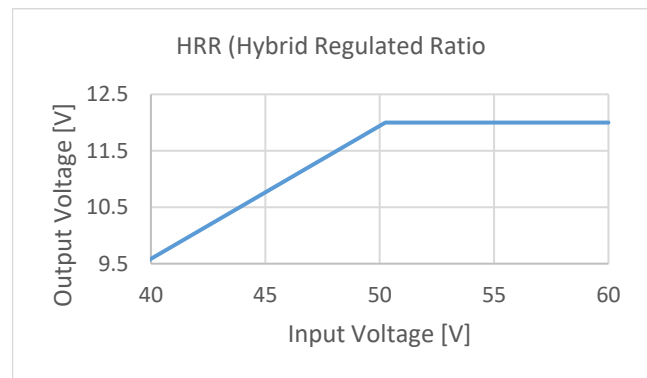

### Margin Up/Down Controls

These controls allow the output voltage to be momentarily adjusted, either up or down, by a nominal 10%. The margin high and margin low shall be limited to max and min output voltage, if the nominal output voltage is changed. This provides a convenient method for dynamically testing the operation of the load circuit over its supply margin or range. It can also be used to verify the function of supply voltage supervisors.

The margin up and down levels of the product can easily be re-configured using Flex Power Designer software.

**BMR490 series** Non-isolated DC-DC Converters  
Input 40-60 V, Output up to 139 A / 1300 W

28701-BMR490 Rev D September 2020

© Flex

### Soft-start Power Up

The default rise time for a single product is 10 ms. When starting by applying input voltage the control circuit boot-up time adds an additional 25 ms delay. The soft-start and soft-stop control functionality allows the output voltage to ramp-up and ramp-down with defined timing with respect to the control of the output. This can be used to control inrush current and manage supply sequencing of multiple controllers.

The rise time is the time taken for the output to ramp to its target voltage, while the fall time is the time taken for the output to ramp down from its regulation voltage to 0 V. The TON\_DELAY (0x60) time sets a delay from when the output is enabled until the output voltage starts to ramp up. The TOFF\_DELAY (0x64) delay time sets a delay from when the output is disabled until the output voltage starts to ramp down.

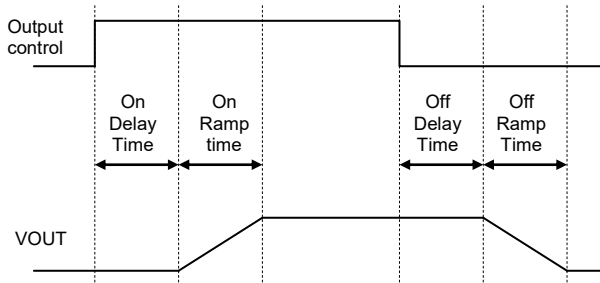

*Illustration of Soft-Start and Soft-Stop.*

By default, soft-stop is disabled, and the regulation of output voltage stops immediately when the output is disabled. Soft-stop can be enabled through the PMBus command ON\_OFF\_CONFIG (0x02). The delay and ramp times can be reconfigured using the PMBus commands TON\_DELAY (0x60), TON\_RISE (0x61), TOFF\_DELAY (0x64) and TOFF\_FALL (0x65).

### Pre-bias Start-up

The product has a Pre-bias start up functionality and will not sink current during start up if a pre-bias source is present at the output terminals. If the Pre-bias voltage is lower than the target value set in VOUT\_COMMAND (0x21), the product will ramp up to the target value. If the Pre-bias voltage is higher than the target value set in VOUT\_COMMAND (0x21), the product will ramp down to the target value and in this case sink current for a time interval set by the command TOFF\_MAX\_WARN\_LIMIT (0x66).

### Over/Under Temperature Protection (OTP, UTP)

The products are protected from thermal overload by an internal over temperature sensor.

The product will make continuous attempts to start up (non-latching mode) and resume normal operation automatically when the temperature has dropped below the temperature threshold set in command OT\_WARN\_LIMIT (0x51).

The OTP and hysteresis of the product can be re-configured using the PMBus interface. The product has also an under-temperature protection. The OTP and UTP fault limit and fault response can be configured via the PMBus. Note: using the

fault response “continue without interruption” may cause permanent damage to the product

### Input Over/Under Voltage Protection

The product can be protected from high input voltage and low input voltage by a pre-configured value with a response time of 100us. The over/under-voltage fault level and fault response is easily configured using Flex Power Designer software, see also Appendix – PMBus commands.

### Output Over Voltage Protection (OVP)

The product includes over voltage limiting circuitry for protection of the load. The default OVP limit is 30% above the nominal output voltage. If the output voltage exceeds the OVP limit, the product can respond in different ways.

The default response from an over voltage fault is to immediately shut down. The device will continuously check for the presence of the fault condition, and when the fault condition no longer exists the device will be re-enabled.

The OVP fault level and fault response can be configured via the PMBus interface, see Appendix – PMBus commands.

### Over Current Protection (OCP)

The products include current limiting circuitry for protection at continuous overload. For standard configuration the output voltage will decrease towards  $0.3 \times V_{out}$ , set in command IOUT\_OC\_LV\_FAULT\_LIMIT (0x48), then shutdown and automatic restart for output currents in excess of max output current (max Io). The product will resume normal operation after removal of the overload. The load distribution should be designed for the maximum output short circuit current specified.

The over current protection of the product can be configured via the PMBus interface, see Appendix – PMBus commands.

### Synchronization

It is possible to synchronize 2 or more products by connecting pins 6 (PG/SYNC) or 14 (SA1), see Multi Pin Configuration. To utilize the synchronization one product must be configured to sync out. The other products must be configured as sync in. The function is enabled and configured to be sync out or sync in via MFR\_MULTI\_PIN\_CONFIG (0xF9). The synchronization can be configured to use interleave between the switching phases. Synchronization can be configured via the PMBus interface, see Appendix – PMBus commands, MFR\_MULTI\_PIN\_CONFIG (0xF9).

### Interleave

When multiple product share a common DC input supply, spreading of the switching phases between the products can be utilized. This reduces the input capacitance requirements and efficiency losses, since the peak current drawn from the input supply is effectively spread out over the whole switch period. If two or more units have their outputs connected in parallel, interleaving will reduce ripple currents. This requires that the products are synchronized using the SYNC pin. Interleave function can be configured via the PMBus interface, see Appendix – PMBus commands, INTERLEAVE (0x37). The default configuration is set to 0x0021.



Technical Specification

**BMR490 series** Non-isolated DC-DC Converters  
 Input 40-60 V, Output up to 139 A / 1300 W

28701-BMR490 Rev D September 2020

© Flex

Byte	High Byte				Low Byte											
Bit Number	7	6	5	4	3	2	1	0	7	6	5	4	3	2	1	0
Contents	Not Used				Group ID Number				Number In Group				Interleave Order			
Default Value	00				00				00				00			

$$Phase\_offset(^{\circ}) = 360^{\circ} \times \frac{Interleave\_order}{Number\_in\_group}$$

For more details about how to setup Interleave, refer to the PMBus specification

**Switching frequency**

The switching frequency is set to 230kHz as default but this can be reconfigured via the PMBus interface. The product is optimized at this frequency, but can run at lower and higher frequency (180kHz-250kHz). The electrical performance can be affected if the switching frequency is changed.

**Power Good**

The power good pin 6(PG\_SYNC) indicates when the product is ready to provide regulated output voltage to the load. During ramp-up and during a fault condition, PG is held high. By default, PG is asserted low after the output has ramped to a voltage above 8V, and de-asserted if the output voltage falls below 5V. These thresholds may be changed using the PMBus commands POWER\_GOOD\_ON (0x5E) and POWER\_GOOD\_OFF (0x5F).

By default, the PG pin is configured as Push/pull output, but it is also possible to set the output in open drain mode by the command MFR\_MULTI\_PIN\_CONFIG (0xF9), see Appendix – PMBus commands.

The polarity is by default configured to active low, the polarity of PG can be set to active high in the command MFR\_PGOOD\_POLARITY (0xD0):  
 0xD0 = 00 (active low)  
 0xD0 = 01 (active high)

The product provides Power Good flag in the Status Word register that indicates the output voltage is within a specified tolerance of its target level and no-fault condition exists.

It is not recommended to use Push-pull when paralleling PG-pins.

**DBV (Dynamic Bus Voltage)**

The MFR\_DBV\_CONFIG (0xEF) command can be used when the output voltage shall change depending on the output current load, which can improve the energy consumption. In MFR\_DBV\_CONFIG there are 4 current thresholds, low to mid (I1H), mid to low (I1L), mid to high (I2H) and high to mid (I2L) and 2 voltage levels that can be set, V1 and V2, V3 is the default setting in VOUT\_COMMAND (0x21).

The Vout rise time is configured via VOUT\_TRANSITION\_RATE (0x27), consider that the max output current or power can't be exceeded when entering different Vout levels.

The MFR\_DBV\_CONFIG is easily configured using Flex Power Designer software, see also Appendix – PMBus commands.

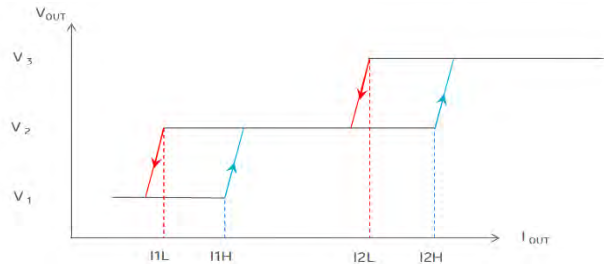

**ART (Adaptive Ramp-up Time)**

MFR\_DLC\_CONFIG (0xF7) command combines ART and DLC functions. This section describes the ART function. It can be useful when adaptive rise time is requested, referenced to the output capacitive load.

From start of ramp-up, TON\_RISE (0x61) is used. V<sub>end</sub> and V<sub>start</sub> state the levels on the ramp where the output capacitance is measured. The values K1, K2 and K3 set the ramp factor multiplied to the default TON\_RISE value. The ramp factor is referenced to Limit1, Limit2 and Limit3 stated in MFR\_DLC\_CONFIG.

The MFR\_DLC\_CONFIG is easily configured using Flex Power Designer software, see also Appendix – PMBus commands.

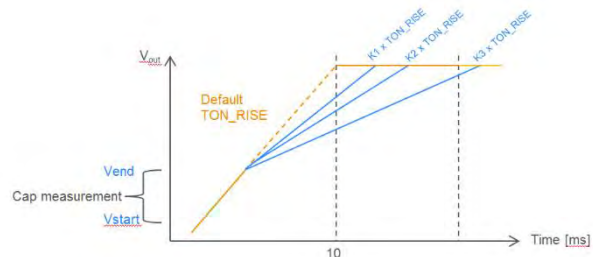

**DLC (Dynamic Load Compensation)**

MFR\_DLC\_CONFIG (0xF7) command combines ART and DLC functions. This section describes the DLC function. The DLC function is useful when optimized parameters for the control loop is requested, referenced to the output capacitive load. Only if the output capacitance is larger than Limit3 the control loop will be changed.

V<sub>end</sub> and V<sub>start</sub> state the levels on the ramp where the output capacitance is measured. At the end of this measurement the control loop can possibly change depending on the configuration.

The MFR\_DLC\_CONFIG is easily configured using Flex Power Designer, see also Appendix – PMBus commands.

Technical Specification

**BMR490 series** Non-isolated DC-DC Converters  
 Input 40-60 V, Output up to 139 A / 1300 W

28701-BMR490 Rev D September 2020  
 © Flex

**Multi pin configuration**

The MFR\_MULTI\_PIN\_CONFIG (0xF9) command can be re-configured using the PMBus interface to enable or disable different functions and set the pin configuration of the digital header (pin 6-15), see Appendix – PMBus commands. Standard configuration for stand-alone product is set to Power Good Push/pull (0x04). Products that are configured for parallel operation have Power Good configured to Open Drain (0x06). The MULTI\_PIN\_CONFIG is easily configured using Flex Power Designer, see also Appendix – PMBus commands.

**Address Offset**

The command MFR\_OFFSET\_ADDRESS (0xEE) is used to configure an address offset. The PMBus-address offset's value increments the address value following the formula in the PMBus Addressing section of documentation. This increases flexibility when the part is used in single-pin and no-pin addressing scenarios, such as when the SA1 is used instead for Sync. See Appendix – PMBus commands.

**Thermal Consideration**

**General**

The products are designed to operate in different thermal environments and sufficient cooling must be provided to ensure reliable operation.

For products mounted on a PWB without a heat sink attached, cooling is achieved mainly by conduction, from the pins to the host board, and convection, which is dependent on the airflow across the product. Increased airflow enhances the cooling of the product. The Output Current Derating graph found in the Output section for each model provides the available output current vs. ambient air temperature and air velocity at  $V_i = 53$  V.

The product is tested on a 254 x 254 mm, 35  $\mu$ m (1 oz), 16-layer test board mounted vertically in a wind tunnel with a cross-section of 608 x 203 mm.

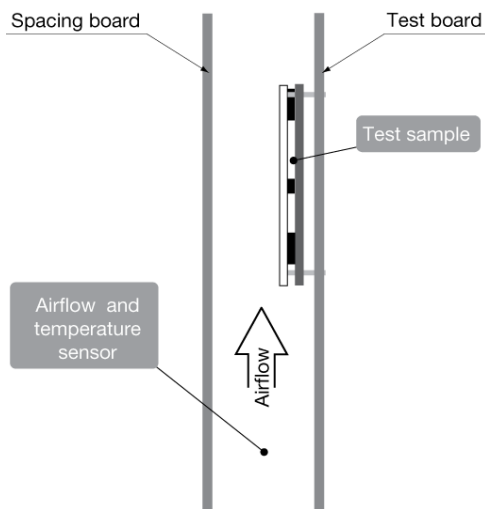

For products with base plate used in a sealed box/cold wall application, cooling is achieved mainly by conduction through the cold wall. The Output Current Derating graphs are found in the Output section for each model. The product is tested in a sealed box test set up with ambient temperatures 85°C. See Design Note 028 for further details.

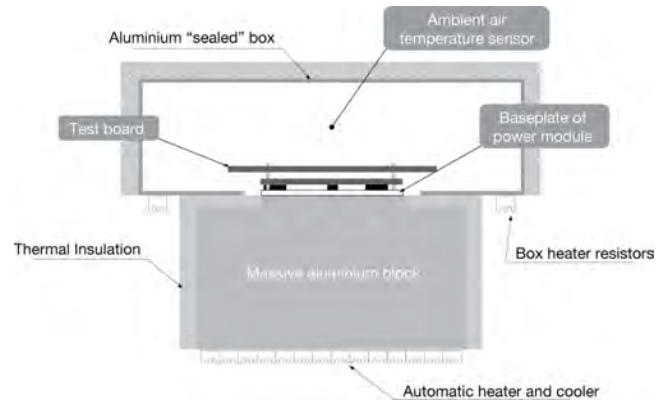

**Definition of product operating temperature**

The product operating temperatures is used to monitor the temperature of the product, and proper thermal conditions can be verified by measuring the temperature at positions P1 and P2. The temperature at these positions ( $T_{P1}$ ,  $T_{P2}$ ) should not exceed the maximum temperatures in the table below. The number of measurement points may vary with different thermal design and topology. Temperatures above maximum  $T_{P1}$ , measured at the reference point P1 are not allowed and may cause permanent damage.

Position	Description	Max Temp.
P1	PWB reference point	$T_{P1} = 125^\circ\text{C}$

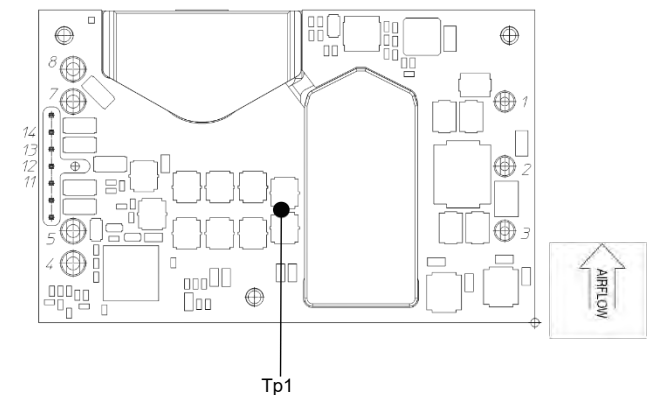

Base plate (Bottom view)

Technical Specification

**BMR490 series** Non-isolated DC-DC Converters  
 Input 40-60 V, Output up to 139 A / 1300 W

28701-BMR490 Rev D September 2020  
 © Flex

**Ambient Temperature Calculation**

For products with base plate the maximum allowed ambient temperature can be calculated by using the thermal resistance.

1. The power loss is calculated by using the formula  $((1/\eta) - 1) \times \text{output power} = \text{power losses (Pd)}$ .  
 $\eta$  = efficiency of product. E.g. 96% = 0.96
2. Find the thermal resistance (Rth) in the Thermal Resistance graph found in the Output section for each model.  
**Note that the thermal resistance can be reduced if a heat sink is mounted on the top of the base plate.**

Calculate the temperature increase ( $\Delta T$ ).  
 $\Delta T = R_{th} \times P_d$

3. Max allowed ambient temperature is:  
 Max  $T_{P1} - \Delta T$ .

E.g. BMR 490 3317 at 4.0m/s:

1.  $(\frac{1}{0.961}) - 1) \times 1300 \text{ W} = 53 \text{ W}$
2.  $53 \text{ W} \times 1.7^\circ\text{C/W} = 90^\circ\text{C}$
3.  $125^\circ\text{C} - 90^\circ\text{C} = \text{max ambient temperature is } 35^\circ\text{C}$
4. The thermal performance can be improved by mounting a heat sink on top of the base plate.

The actual temperature will be dependent on several factors such as the PWB size, number of layers and direction of airflow.

**Connections (Bottom view)**

Pin	Designation	Function
1	+In	Positive Input
2	RC	Remote Control
3	-In	Negative Input
4	-Out	Negative Output
5	-Out	Negative Output
6	PG_Sync	<b>Not Mounted</b>
7	+Out	Positive Output
8	+Out	Positive Output
9	CTRL	<b>Not Mounted</b>
10	DGND	<b>Not Mounted</b>
11	SDA	PMBus Data
12	SALERT	PMBus alert signal
13	SCL	PMBus Clock
14	SA1	PMBus Address 1
15	SA0	<b>Not Mounted</b>

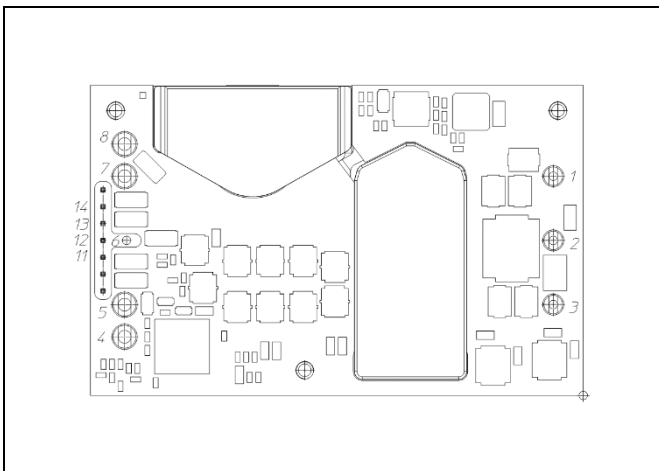

Technical Specification

**BMR490 series** Non-isolated DC-DC Converters  
 Input 40-60 V, Output up to 139 A / 1300 W

28701-BMR490 Rev D

September 2020

© Flex

**Mechanical Information - Hole Mount, Base plate Version**

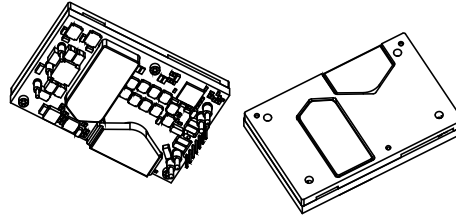
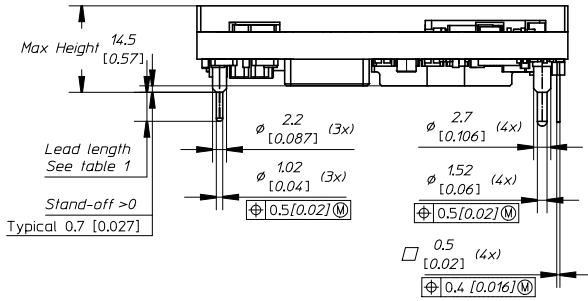

TOP VIEW  
 Pin position according to recommended footprint

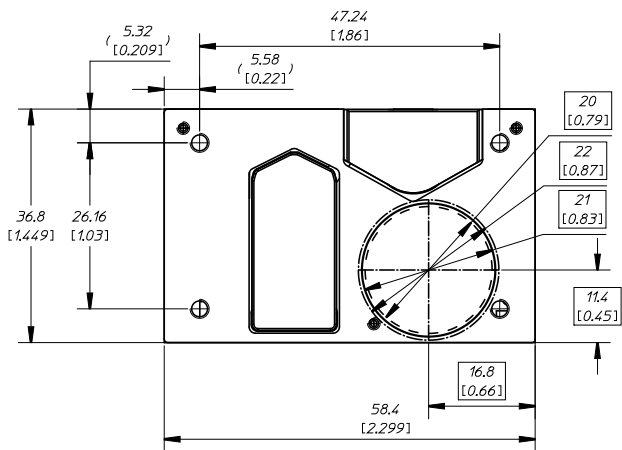

	Lead length
Standard	5.33 [0.210]
LA	3.69 [0.145]
LB	4.57 [0.180]
LC	

PIN SPECIFICATIONS

Pin 1-8 Material: Copper alloy  
 Plating: Min Au 0.1 $\mu$ m over Ni 1-3 $\mu$ m  
 Pin 11-14 Material: Brass  
 Plating: Min Au 0.2 $\mu$ m over Ni 1-3 $\mu$ m

CASE

Material: Aluminum  
 For screw attachment apply mounting torque of max 0.44Nm [3.9lbf in.]. M3 screws must not protrude more than 2.4mm [0.094] into the base plate

RECOMMENDED FOOTPRINT - Top view

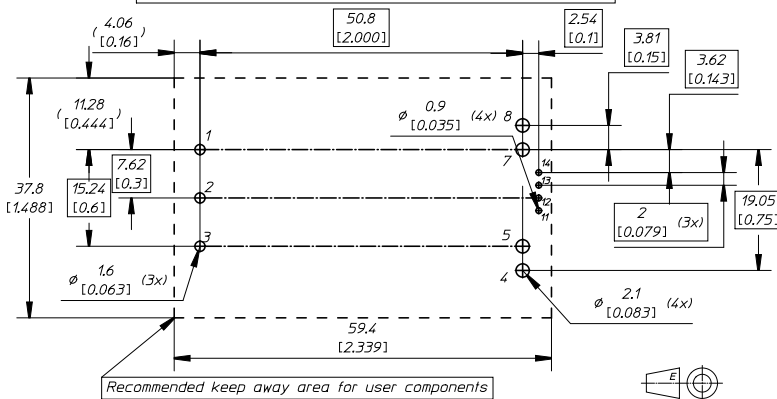

Weight: 89 g  
 All dimensions in mm [inch].  
 Tolerances unless specified  
 x.x mm  $\pm$ 0.50 mm [0.02].  
 x.xx mm  $\pm$ 0.25 mm [0.01]  
 (not applied on footprint or typical values)

Technical Specification

**BMR490 series** Non-isolated DC-DC Converters  
Input 40-60 V, Output up to 139 A / 1300 W

28701-BMR490 Rev D September 2020  
© Flex

**Soldering Information – Hole Mount through Pin in Paste Assembly**

The pin in paste mount product is intended for forced convection or vapor phase reflow soldering in SnPb and Pb-free processes.

The reflow profile should be optimised to avoid excessive heating of the product. It is recommended to have a sufficiently extended preheat time to ensure an even temperature across the host PWB and it is also recommended to minimize the time in reflow.

A no-clean flux is recommended to avoid entrapment of cleaning fluids in cavities inside the product or between the product and the host board, since cleaning residues may affect long time reliability and isolation voltage.

General reflow process specifications		SnPb eutectic	Pb-free
Average ramp-up ( $T_{PRODUCT}$ )		3°C/s max	3°C/s max
Typical solder melting (liquidus) temperature	$T_L$	183°C	221°C
Minimum reflow time above $T_L$		60 s	60 s
Minimum pin temperature	$T_{PIN}$	210°C	235°C
Peak product temperature	$T_{PRODUCT}$	225°C	260°C
Average ramp-down ( $T_{PRODUCT}$ )		6°C/s max	6°C/s max
Maximum time 25°C to peak		6 minutes	8 minutes

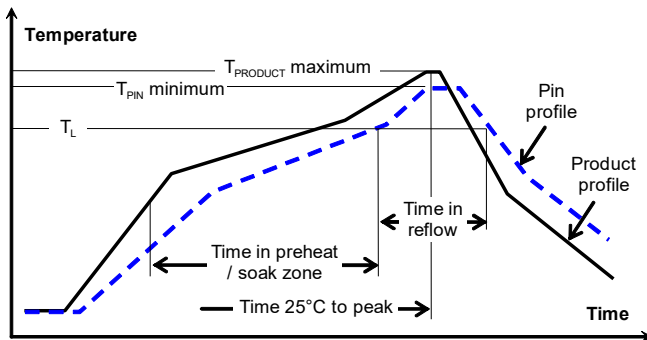

**Thermocoupler Attachment**

$T_{PRODUCT}$  is measured on the base plate top side, since this will likely be the warmest part of the product during the reflow process.

$T_{PIN}$  temperature is measured on the power module pins solder joints at customer board.

**Product reflow classification**

The product has been tested for the following

**Pb-free solder classification**

For Pb-free solder processes, the product is qualified for MSL 3 according to IPC/JEDEC standard J-STD-020C.

**Product reflow processes**

**SnPb solder processes**

For SnPb solder processes, a pin temperature ( $T_{PIN}$ ) in excess of the solder melting temperature, ( $T_L$ , 183°C for Sn63Pb37) for more than 60 seconds and a peak temperature of 220°C is recommended to ensure a reliable solder joint.

For dry packed products only: depending on the type of solder paste and flux system used on the host board, up to a recommended maximum temperature of 245°C could be used, if the products are kept in a controlled environment (dry pack handling and storage) prior to assembly.

**Lead-free (Pb-free) solder processes**

For Pb-free solder processes, a pin temperature ( $T_{PIN}$ ) in excess of the solder melting temperature ( $T_L$ , 217 to 221°C for SnAgCu solder alloys) for more than 60 seconds and a peak temperature of 245°C on all solder joints is recommended to ensure a reliable solder joint.

**Dry Pack Information**

Products intended for Pb-free reflow soldering processes are delivered in standard moisture barrier bags according to IPC/JEDEC standard J-STD-033 (Handling, packing, shipping and use of moisture/reflow sensitivity surface mount devices).

Using products in high temperature Pb-free soldering processes requires dry pack storage and handling. In case the products have been stored in an uncontrolled environment and no longer can be considered dry, floor life according to MSL 3, the modules must be baked according to J-STD-033.

Technical Specification

**BMR490 series** Non-isolated DC-DC Converters  
 Input 40-60 V, Output up to 139 A / 1300 W

28701-BMR490 Rev D September 2020  
 © Flex

**Soldering Information - Hole Mounting**

The hole mounted product is intended for plated through hole mounting by wave or manual soldering. The pin temperature is specified to maximum to 270°C for maximum 10 seconds.

A maximum preheat rate of 4°C/s and maximum preheat temperature of 150°C is suggested. When soldering by hand, care should be taken to avoid direct contact between the hot soldering iron tip and the pins for more than a few seconds in order to prevent overheating.

A no-clean flux is recommended to avoid entrapment of cleaning fluids in cavities inside the product or between the product and the host board. The cleaning residues may affect long time reliability and isolation voltage.

**Delivery Package Information**

The products are delivered in antistatic polystyrene trays and in antistatic PE foam trays.

Tray Specifications – Through hole pin in paste & base plate version (both dry pack)	
<b>Material</b>	Antistatic Polystyrene (black)
<b>Surface resistance</b>	$10^5 < \text{Ohm/square} < 10^{11}$
<b>Bakability</b>	The trays cannot be baked
<b>Tray thickness</b>	25.8 mm 1.02 [inch] (TH PiP version) 25 mm 0.984 [inch] (Base plate version)
<b>Box capacity</b>	48 products (4 full trays/box)
<b>Tray weight</b>	56 g empty, 704 g full tray (TH PiP) 58 g empty, 898 g full tray (Base plate)

a

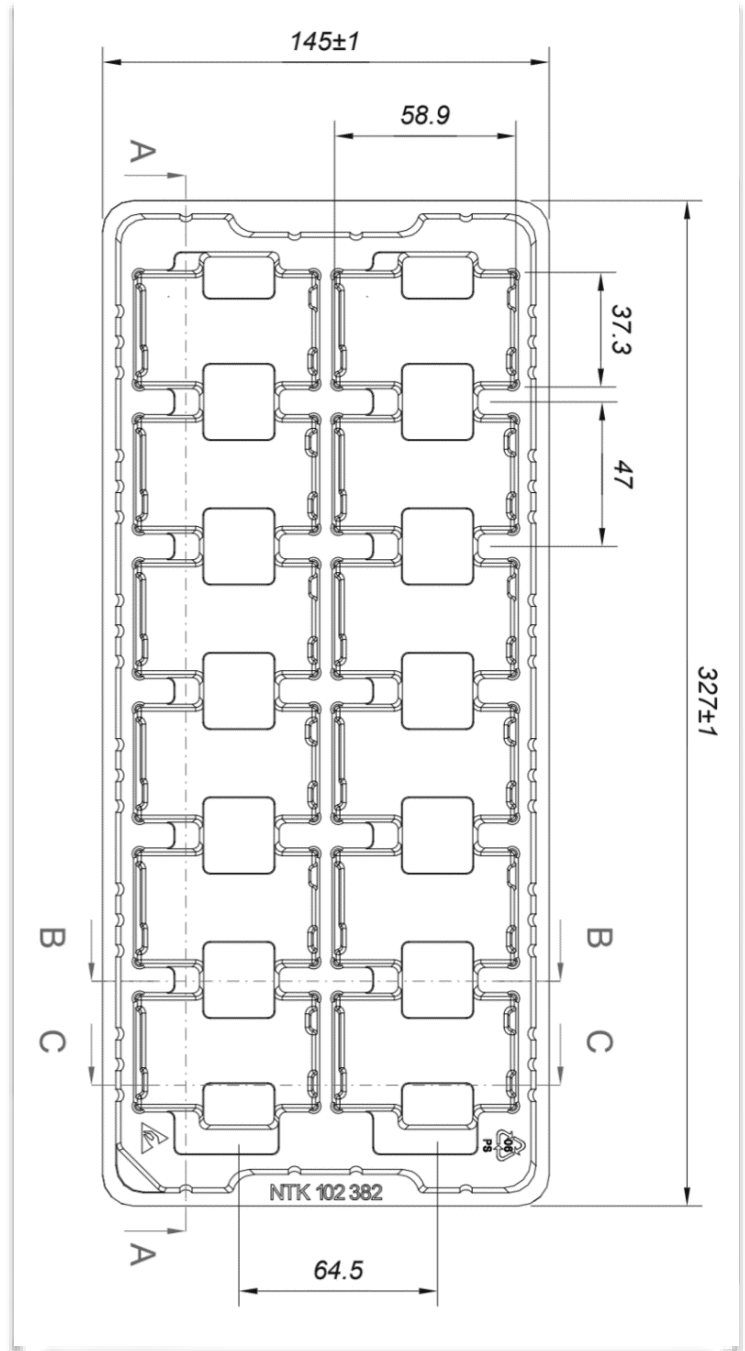

JEDEC standard tray for 2x6 = 12 products.  
 All dimensions in mm  
 Tolerances: X.x ±0.26 [0.01], X.xx ±0.13 [0.005]  
 Note: pick up positions refer to center of pocket.  
 See mechanical drawing for exact location on product.

Technical Specification

**BMR490 series** Non-isolated DC-DC Converters  
 Input 40-60 V, Output up to 139 A / 1300 W

28701-BMR490 Rev D September 2020  
 © Flex

Tray Specifications – Through hole version & BP version without dry pack	
<b>Material</b>	PE Foam
<b>Surface resistance</b>	$10^5 < \text{Ohm/square} < 10^{11}$
<b>Bakability</b>	The trays are not bakeable
<b>Tray capacity</b>	20 converters/tray
<b>Box capacity</b>	60 products (3 full trays/box)
<b>Weight</b>	1020 g full tray, 140 g empty tray

Tray Specifications –base plate version (dry pack, pick & place) (“H” option)	
<b>Material</b>	Antistatic PPE
<b>Surface resistance</b>	$10^5 < \text{Ohm/square} < 10^{11}$
<b>Bakability</b>	The trays can be baked at maximum 125°C for 48 hours
<b>Tray capacity</b>	10 converters/tray
<b>Box capacity</b>	40 products (4 full trays/box)
<b>Weight</b>	1100 g full tray, 220 g empty tray

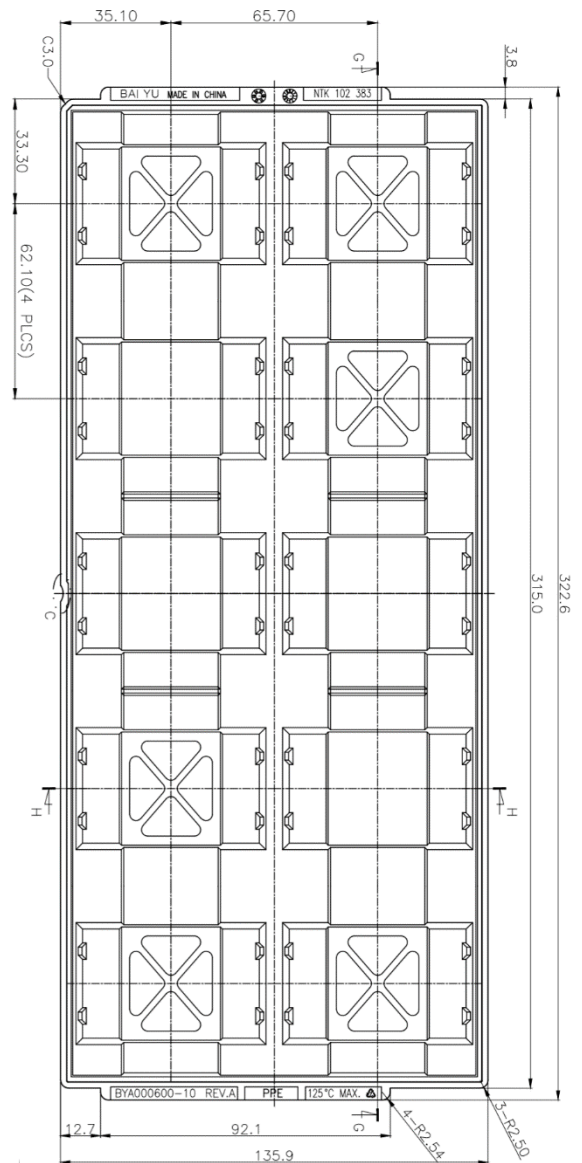
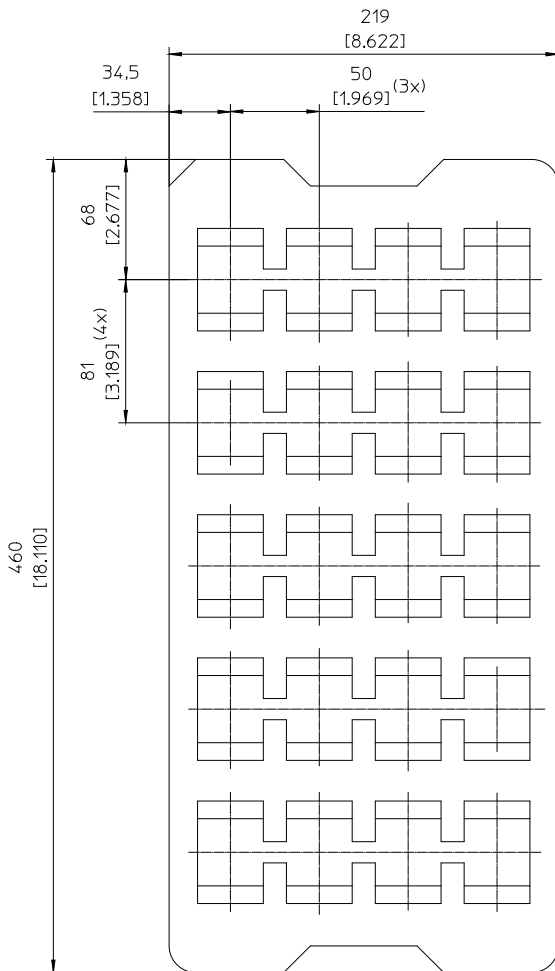

## Technical Specification

<b>BMR490 series</b> Non-isolated DC-DC Converters Input 40-60 V, Output up to 139 A / 1300 W	28701-BMR490 Rev D	September 2020
	© Flex	

## Product Qualification Specification

Characteristics			
External visual inspection	IPC-A-610		
Change of temperature (Temperature cycling)	IEC 60068-2-14 Na	Temperature range Number of cycles Dwell/transfer time	-40 to 100°C 1000 15 min/0-1 min
Cold (in operation)	IEC 60068-2-1 Ad	Temperature T <sub>A</sub> Duration	-45°C 72 h
Damp heat	IEC 60068-2-67 Cy	Temperature Humidity Duration	85°C 85 % RH 1000 hours
Dry heat	IEC 60068-2-2 Bd	Temperature Duration	125°C 1000 h
Electrostatic discharge susceptibility	IEC 61340-3-1, JESD 22-A114 IEC 61340-3-2, JESD 22-A115	Human body model (HBM) Machine Model (MM)	Class 2, 2000 V Class 3, 200 V
Immersion in cleaning solvents	IEC 60068-2-45 XA, method 2	Water Glycol ether	55°C 35°C
Mechanical shock	IEC 60068-2-27 Ea	Peak acceleration Duration	100 g 6 ms
Moisture reflow sensitivity <sup>1</sup>	J-STD-020E	Level 1 (SnPb-eutectic) Level 3 (Pb Free)	225°C 260°C
Operational life test	MIL-STD-202G, method 108A	Duration	1000 h
Resistance to soldering heat <sup>2</sup>	IEC 60068-2-20 Tb, method 1A	Solder temperature Duration	270°C 10-13 s
Robustness of terminations	IEC 60068-2-21 Test Ua1 IEC 60068-2-21 Test Ue1	Through hole mount products Surface mount products	All leads All leads
Solderability	IEC 60068-2-20 test Ta	Preconditioning Temperature, Pb-free	Steam ageing 245°C
Vibration, broad band random	IEC 60068-2-64 Fh, method 1	Frequency Spectral density Duration	10 to 500 Hz 0.07 g <sup>2</sup> /Hz 10 min in each direction

## Notes

<sup>1</sup> Only for products intended for reflow soldering (surface mount products & pin-in paste<sup>3</sup> products)

<sup>2</sup> Only for products intended for wave soldering (plated through hole products)



## Technical Specification

<b>BMR490 series</b> Non-isolated DC-DC Converters Input 40-60 V, Output up to 139 A / 1300 W	28701-BMR490 Rev D	September 2020
	© Flex	

This appendix contains a detailed reference of the PMBus commands supported by the product.

### Data Formats

The products make use of a few standardized numerical formats, along with custom data formats. A detailed walkthrough of the above formats is provided in AN304, as well as in sections 7 and 8 of the PMBus Specification Part II. The custom data formats vary depending on the command, and are detailed in the command description.

### Standard Commands

The functionality of commands with code 0x00 to 0xCF is usually based on the corresponding command specification provided in the PMBus Standard Specification Part II (see Power System Management Bus Protocol Documents below). However there might be different interpretations of the PMBus Standard Specification or only parts of the Standard Specification applied, thus the detailed command description below should always be consulted.

### Forum Websites

The System Management Interface Forum (SMIF)

<http://www.powersig.org/>

The System Management Interface Forum (SMIF) supports the rapid advancement of an efficient and compatible technology base that promotes power management and systems technology implementations. The SMIF provides a membership path for any company or individual to be active participants in any or all of the various working groups established by the implementer forums.

Power Management Bus Implementers Forum  
(PMBUS-IF)

<http://pmbus.org/>

The PMBus-IF supports the advancement and early adoption of the PMBus protocol for power management. This website offers recent PMBus specification documents, PMBus articles, as well as upcoming PMBus presentations and seminars, PMBus Document Review Board (DRB) meeting notes, and other PMBus related news.

### PMBus – Power System Management Bus Protocol Documents

These specification documents may be obtained from the PMBus-IF website described above. These are required reading for complete understanding of the PMBus implementation. This appendix will not re-address all of the details contained within the two PMBus Specification documents.

Specification Part I – General Requirements Transport And Electrical Interface

Includes the general requirements, defines the transport and electrical interface and timing requirements of hard wired signals.

Specification Part II – Command Language

Describes the operation of commands, data formats, fault management and defines the command language used with the PMBus.

### SMBus – System Management Bus Documents

System Management Bus Specification, Version 2.0, August 3, 2000

This specification specifies the version of the SMBus on which Revision 1.2 of the PMBus Specification is based. This specification is freely available from the System Management Interface Forum Web site at:

<http://www.smbus.org/specs/>

## Technical Specification

<b>BMR490 series</b> Non-isolated DC-DC Converters Input 40-60 V, Output up to 139 A / 1300 W	28701-BMR490 Rev D	September 2020
	© Flex	

**PMBus Command Summary and Factory Default Values of Standard Configuration**

The factory default values provided in the table below are valid for the Standard configuration. Factory default values for other configurations can be found using the Flex Power Designer tool.

Code	Name	Data Format	Factory Default Value Standard Configuration BMR 490 XXX7/820 R1	
0x01	OPERATION	R/W Byte	0x84	
0x02	ON_OFF_CONFIG	R/W Byte	0x18	
0x03	CLEAR_FAULTS	Send Byte		
0x10	WRITE_PROTECT	R/W Byte		
0x11	STORE_DEFAULT_ALL	Send Byte		
0x12	RESTORE_DEFAULT_ALL	Send Byte		
0x15	STORE_USER_ALL	Send Byte		
0x16	RESTORE_USER_ALL	Send Byte		
0x19	CAPABILITY	Read Byte		
0x20	VOUT_MODE	Read Byte	0x15	
0x21	VOUT_COMMAND	R/W Word	0x6000	12.0 V
0x22	VOUT_TRIM	R/W Word	0x0000	0.0 V
0x23	VOUT_CAL_OFFSET	R/W Word	Unit Specific	
0x24	VOUT_MAX	R/W Word	0x7333	14.4 V
0x25	VOUT_MARGIN_HIGH	R/W Word	0x6000	12.0 V
0x26	VOUT_MARGIN_LOW	R/W Word	0x5666	10.8 V
0x27	VOUT_TRANSITION_RATE	R/W Word	0x9B02	0.1 V/ms
0x28	VOUT_DROOP	R/W Word	0xE800	0.0 mV/A
0x29	VOUT_SCALE_LOOP	R/W Word	Unit Specific	
0x2A	VOUT_SCALE_MONITOR	R/W Word	Unit Specific	
0x32	MAX_DUTY	R/W Word	0xEB18	99.0 %
0x33	FREQUENCY_SWITCH	R/W Word	0x00B4	180.0 kHz
0x35	VIN_ON	R/W Word	0x0025	37.0 V
0x36	VIN_OFF	R/W Word	0x0023	35.0 V
0x37	INTERLEAVE	R/W Word	0x0021	
0x39	IOUT_CAL_OFFSET	Read Word	Unit Specific	
0x40	VOUT_OV_FAULT_LIMIT	R/W Word	0x7CCC	15.6 V
0x41	VOUT_OV_FAULT_RESPONSE	R/W Byte	0xC0	
0x42	VOUT_OV_WARN_LIMIT	R/W Word	0x7800	15.0 V
0x43	VOUT_UV_WARN_LIMIT	R/W Word	0x0000	0.0 V
0x44	VOUT_UV_FAULT_LIMIT	R/W Word	0x0000	0.0 V
0x45	VOUT_UV_FAULT_RESPONSE	R/W Byte	0x00	
0x46	IOUT_OC_FAULT_LIMIT	R/W Word	0x0096	150.0 A
0x47	IOUT_OC_FAULT_RESPONSE	R/W Byte	0x7B	
0x48	IOUT_OC_LV_FAULT_LIMIT	R/W Word	0x4000	8.0 V
0x4A	IOUT_OC_WARN_LIMIT	R/W Word	0x0096	150.0 A
0x4F	OT_FAULT_LIMIT	R/W Word	0x007D	125.0 °C
0x50	OT_FAULT_RESPONSE	R/W Byte	0xC0	
0x51	OT_WARN_LIMIT	R/W Word	0x005A	90.0 °C
0x52	UT_WARN_LIMIT	R/W Word	0x07D8	-40.0 °C
0x53	UT_FAULT_LIMIT	R/W Word	0x07CE	-50.0 °C
0x54	UT_FAULT_RESPONSE	R/W Byte	0x00	
0x55	VIN_OV_FAULT_LIMIT	R/W Word	0x0055	85.0 V
0x56	VIN_OV_FAULT_RESPONSE	R/W Byte	0xC0	
0x57	VIN_OV_WARN_LIMIT	R/W Word	0x0055	85.0 V
0x58	VIN_UV_WARN_LIMIT	R/W Word	0xE324	50.2 V
0x59	VIN_UV_FAULT_LIMIT	R/W Word	0x0000	0.0 V
0x5A	VIN_UV_FAULT_RESPONSE	R/W Byte	0x00	
0x5E	POWER_GOOD_ON	R/W Word	0x4000	8.0 V
0x5F	POWER_GOOD_OFF	R/W Word	0x2800	5.0 V
0x60	TON_DELAY	R/W Word	0x0000	
0x61	TON_RISE	R/W Word	0x000A	
0x62	TON_MAX_FAULT_LIMIT	R/W Word	0x000F	

## Technical Specification

**BMR490 series** Non-isolated DC-DC Converters  
Input 40-60 V, Output up to 139 A / 1300 W

28701-BMR490 Rev D

September 2020

© Flex

Code	Name	Data Format	Factory Default Value Standard Configuration BMR 490 XXX7/820 R1	
0x63	TON_MAX_FAULT_RESPONSE	R/W Byte	0x00	
0x64	TOFF_DELAY	R/W Word	0x0005	
0x65	TOFF_FALL	R/W Word	0x000A	
0x66	TOFF_MAX_WARN_LIMIT	R/W Word	0x000F	
0x78	STATUS_BYTE	Read Byte		
0x79	STATUS_WORD	Read Word		
0x7A	STATUS_VOUT	Read Byte		
0x7B	STATUS_IOUT	Read Byte		
0x7C	STATUS_INPUT	Read Byte		
0x7D	STATUS_TEMPERATURE	Read Byte		
0x7E	STATUS_CML	Read Byte		
0x88	READ_VIN	Read Word		
0x8B	READ_VOUT	Read Word		
0x8C	READ_IOUT	Read Word		
0x8D	READ_TEMPERATURE_1	Read Word		
0x8E	READ_TEMPERATURE_2	Read Word		
0x94	READ_DUTY_CYCLE	Read Word		
0x95	READ_FREQUENCY	Read Word		
0x98	PMBUS_REVISION	Read Byte		
0x99	MFR_ID	R/W Block12	Unit Specific	
0x9A	MFR_MODEL	R/W Block20	Unit Specific	
0x9B	MFR_REVISION	R/W Block12	Unit Specific	
0x9C	MFR_LOCATION	R/W Block12	Unit Specific	
0x9D	MFR_DATE	R/W Block12	Unit Specific	
0x9E	MFR_SERIAL	R/W Block20	Unit Specific	
0xB0	USER_DATA_00	R/W Block16	Unit Specific	
0xC4	MFR_VIN_OV_WARN_RESPONSE	R/W Byte	0xC0	
0xC5	MFR_CONFIG_UNUSED_PINS	R/W Word	0x00F0	
0xC6	MFR_RC_LEVEL	R/W Byte	0x00	
0xC7	MFR_KS_PRETRIG	R/W Byte	0x89	
0xC8	MFR_FAST_VIN_OFF_OFFSET	R/W Byte	0x20	
0xD0	MFR_PGOOD_POLARITY	R/W Byte	0x00	
0xD1	MFR_FAST_OCP_CFG	R/W Word	0x02EF	111 level, 2 samples
0xD2	MFR_RESPONSE_UNIT_CFG	R/W Byte	0x55	
0xD3	MFR_VIN_SCALE_MONITOR	Read Block4	Unit Specific	
0xD4	MFR_PREBIAS_DVDT_CFG	R/W Block8	0x1E001E00F0040401	
0xD5	MFR_FILTER_SELECT	R/W Byte	0x00	
0xD7	MFR_GET_SNAPSHOT	Read Block32		
0xD8	MFR_TEMP_COMPENSATION	Read Block8	0x009590008580007F	
0xD9	MFR_SET_ROM_MODE	Write Block4		
0xDA	MFR_ISHARE_THRESHOLD	R/W Block8	0x0000000000000000	
0xDB	MFR_GET_RAMP_DATA	Read Block32		
0xDC	MFR_SELECT_TEMPERATURE_SENSOR	R/W Byte	0x00	
0xDD	MFR_VIN_OFFSET	Read Block4	Unit Specific	
0xDE	MFR_VOUT_OFFSET_MONITOR	Read Word	Unit Specific	
0xDF	MFR_GET_STATUS_DATA	Read Block32		
0xE0	MFR_SPECIAL_OPTIONS	R/W Byte	0x40	
0xE1	MFR_TEMP_OFFSET_INT	Read Word	Unit Specific	
0xE2	MFR_REMOTE_TEMP_CAL	Read Block4	Unit Specific	
0xE3	MFR_REMOTE_CTRL	R/W Byte	0x15	
0xE6	MFR_VFF_PARAMS	R/W Block4	0x0E010800	
0xE7	MFR_TEMP_COEFF	Read Block6	0x00EFFF00FF00	
0xE8	MFR_FILTER_COEFF	R/W Block27	0x01DF0267FF00000000550355030000 000050001800000058023501	
0xE9	MFR_FILTER_NLR_GAIN	R/W Block16	0x090000000000000000000000FF0 0	
0xEB	MFR_MIN_DUTY	R/W Word	0x4C46	70 ns, 76 ns

## Technical Specification

**BMR490 series** Non-isolated DC-DC Converters  
Input 40-60 V, Output up to 139 A / 1300 W

28701-BMR490 Rev D September 2020

© Flex

Code	Name	Data Format	Factory Default Value Standard Configuration BMR 490 XXX7/820 R1	
0xEC	MFR_ACTIVE_CLAMP	Read Word	0x1245	69 x4 ns, 18 x4 ns
0xEE	MFR_OFFSET_ADDRESS	R/W Byte	0x60	96 n + SA0
0xEF	MFR_DBV_CONFIG	R/W Block6	0x7A76283E3A20	
0xF0	MFR_DEBUG_BUFF	R/W Block8		
0xF1	MFR_SETUP_PASSWORD	R/W Block12		
0xF2	MFR_DISABLE_SECURITY_ONCE	R/W Block6		
0xF4	MFR_SECURITY_BIT_MASK	Read Block32		
0xF5	MFR_TRANSFORMER_TURN	Read Byte	0x41	
0xF6	MFR_OSC_TRIM	Read Byte	0x00	
0xF7	MFR_DLC_CONFIG	R/W Block8	0x0000000000000000	
0xF8	MFR_ILIM_SOFTSTART	R/W Byte	0x14	20 %
0xF9	MFR_MULTI_PIN_CONFIG	R/W Byte	0x04	
0xFC	MFR_ADDED_DROOP_DURING_RAMP	R/W Word	0xE800	0.0 mV/A
0xFD	MFR_FIRMWARE_DATA	Read Block20		
0xFE	MFR_RESTART	Write Block4		

## Technical Specification

<b>BMR490 series</b> Non-isolated DC-DC Converters Input 40-60 V, Output up to 139 A / 1300 W	28701-BMR490 Rev D	September 2020
	© Flex	

## PMBus Command Details

**OPERATION (0x01)**

Description: Sets the desired PMBus enable and margin operations.

Bit	Function	Description	Value	Function	Description
7:6	Enable	Make the device enable or disable.	00	Immediate Off	Disable Immediately without sequencing.
			01	Soft Off	Disable "Softly" with sequencing.
			10	Enable	Enable device to the desired margin state.
5:4	Margin	Select between margin high/low states or nominal output.	00	Nominal	Operate at nominal output voltage.
			01	Margin Low	Operate at margin low voltage set in <code>VOUT_MARGIN_LOW</code> .
			10	Margin High	Operate at margin high voltage set in <code>VOUT_MARGIN_HIGH</code> .
3:2	Act on Fault	Set 10b to act on fault or set to 01b to ignore fault.	01	Ignore Faults	Ignore Faults when in a margined state. The device will ignore appropriate overvoltage/undervoltage warnings and faults and respond as programmed by the warning limit or fault response command.
			10	Act on Faults	Act on Faults when in a margined state. The device will handle appropriate overvoltage/undervoltage warnings and faults and respond as programmed by the warning limit or fault response command.

**ON\_OFF\_CONFIG (0x02)**

Description: Configures how the device is controlled by the CONTROL pin and the PMBus.

Bit	Function	Description	Value	Function	Description
4	Powerup Operation	Sets the default to either operate any time power is present or for the on/off to be controlled by CONTROL pin and serial bus commands.	0	Enable Always	Unit powers up any time power is present regardless of state of the CONTROL pin.
			1	Enable pin or PMBus	Unit does not power up until commanded by the CONTROL pin and OPERATION command.
3	PMBus Enable Mode	Controls how the unit responds to commands received via the serial bus.	0	Ignore PMBus	Unit ignores the on/off portion of the OPERATION command from serial bus.
			1	Use PMBus	To start, the unit requires that the on/off portion of the OPERATION command is instructing the unit to run.
2	Enable Pin Mode	Controls how the unit responds to the CONTROL pin.	0	Ignore pin	Unit ignores the CONTROL/Enable pin.
			1	Use pin	Unit requires the CONTROL pin to be asserted to start the unit.
1	Enable Pin Polarity	Polarity of the CONTROL pin.	0	Active Low	Enable pin will cause device to enable when driven low.
			1	Active High	Enable pin will cause device to enable when driven high.
0	Disable Action	CONTROL pin action when commanding the unit to turn off.	0	Soft Off	Use the programmed turn off delay and fall time.

## Technical Specification

<b>BMR490 series</b> Non-isolated DC-DC Converters Input 40-60 V, Output up to 139 A / 1300 W	28701-BMR490 Rev D	September 2020
	© Flex	

Bit	Function	Description	Value	Function	Description
			1	Imm. Off	Turn off the output and stop transferring energy to the output as fast as possible. The device's product literature shall specify whether or not the device sinks current to decrease the output voltage fall time.

**CLEAR\_FAULTS (0x03)**

Description: Clears all fault status bits

**WRITE\_PROTECT (0x10)**

Description: The WRITE\_PROTECT command is used to control writing to the PMBus device. The intent of this command is to provide protection against accidental changes. This command is not intended to provide protection against deliberate or malicious changes to a device's configuration or operation.

Bit	Description	Value	Function	Description
7:0	All supported commands may have their parameters read, regardless of the WRITE_PROTECT settings.	0x80	Disable all writes	Disable all writes except to the WRITE_PROTECT command.
		0x40	Enable operation	Disable all writes except to the WRITE_PROTECT, OPERATION and PAGE commands.
		0x20	Enable control and Vout commands	Disable all writes except to the WRITE_PROTECT, OPERATION, PAGE, ON_OFF_CONFIG and VOUT_COMMAND commands.
		0x00	Enable all commands	Enable writes to all commands.

**STORE\_DEFAULT\_ALL (0x11)**

Description: Commands the device to store its configuration into the Default Store.

**RESTORE\_DEFAULT\_ALL (0x12)**

Description: Commands the device to restore its configuration from the Default Store.

**STORE\_USER\_ALL (0x15)**

Description: Stores, at the USER level, all PMBus values that were changed since the last restore command.

**RESTORE\_USER\_ALL (0x16)**

Description: Restores PMBus settings that were stored using STORE\_USER\_ALL. This command is automatically performed at power up.

**CAPABILITY (0x19)**

Description: This command provides a way for a host system to determine some key capabilities of a PMBus device.

Bit	Function	Description	Value	Function	Description
7	Packet Error Checking	Packet error checking.	00	Not supported	Packet Error Checking not supported.
			01	Supported	Packet Error Checking is supported.
6:5	Maximum Bus Speed	Maximum bus speed.	00	100kHz	Maximum supported bus speed is 100 kHz.
			01	400kHz	Maximum supported bus speed is 400 kHz.
3:0	Smbalert	SMBALERT	00	No Smbalert	The device does not have a SMBALERT# pin and does not support the SMBus Alert Response protocol.

## Technical Specification

<b>BMR490 series</b> Non-isolated DC-DC Converters Input 40-60 V, Output up to 139 A / 1300 W	28701-BMR490 Rev D	September 2020
	© Flex	

Bit	Function	Description	Value	Function	Description
			01	Have Smbalert	The device does have a SMBALERT# pin and does support the SMBus Alert Response protocol.

**VOUT\_MODE (0x20)**

Description: Controls how future VOUT-related commands parameters will be interpreted.

Bit	Function	Description	Format
4:0		Five bit two's complement EXPONENT for the MANTISSA delivered as the data bytes for VOUT_COMMAND in VOUT_LINEAR Mode, five bit VID code identifier per in VID Mode or always set to 00000b in Direct Mode.	Integer Signed

Bit	Function	Description	Value	Function	Description
7:5		Set to 000b to select VOUT_LINEAR Mode (Five bit two's complement exponent for the MANTISSA delivered as the data bytes for an output voltage related command), set to 001b to select VID Mode (Five bit VID code identifier per) or set to 010b to select Direct Mode (Always set to 00000b).	000	Linear	Linear Mode Format.
			001	VID	VID Mode.
			010	Direct	Direct Mode.

**VOUT\_COMMAND (0x21)**

Description: Commands the device to transition to a new output voltage.

Bit	Description	Format	Unit
15:0	Sets the nominal value of the output voltage.	Vout Mode Unsigned	V

**VOUT\_TRIM (0x22)**

Description: Configures a fixed offset to be applied to the output voltage when enabled.

Bit	Description	Format	Unit
15:0	Sets VOUT trim value. The two bytes are formatted as a two's complement binary mantissa, used in conjunction with the exponent set in VOUT_MODE.	Vout Mode Signed	V

**VOUT\_CAL\_OFFSET (0x23)**

Description: Vout calibration value. It is a signed number in Vout linear mode. The setting will be applied output voltage.

Bit	Description	Format	Unit
15:0	Vout calibration value. It is a signed number in Vout linear mode. The setting will be applied output voltage.	Vout Mode Signed	V

**VOUT\_MAX (0x24)**

Description: Configures the maximum allowed output voltage.

Bit	Description	Format	Unit
15:0	Sets the maximum possible value setting of VOUT. The maximum VOUT_MAX setting is 110% of the pin-strap setting.	Vout Mode Unsigned	V

**VOUT\_MARGIN\_HIGH (0x25)**

Description: Configures the target for margin-up commands.

## Technical Specification

<b>BMR490 series</b> Non-isolated DC-DC Converters Input 40-60 V, Output up to 139 A / 1300 W	28701-BMR490 Rev D	September 2020
	© Flex	

Bit	Description	Format	Unit
15:0	Sets the value of the VOUT during a margin high.	Vout Mode Unsigned	V

**VOUT\_MARGIN\_LOW (0x26)**

Description: Configures the target for margin-down commands.

Bit	Description	Format	Unit
15:0	Sets the value of the VOUT during a margin low.	Vout Mode Unsigned	V

**VOUT\_TRANSITION\_RATE (0x27)**

Description: Configures the transition time for margins and VCOMMAND output changes.

Bit	Description	Format	Unit
15:0	Sets the transition rate during margin or other change of VOUT.	Linear	V/ms

**VOUT\_DROOP (0x28)**

Description: Configures the Isense voltage to load current ratio.

Bit	Description	Format	Unit
15:0	Sets the effective load line (V/I slope) for the rail in which the device is used.	Linear	mV/A

**VOUT\_SCALE\_LOOP (0x29)**

Description: Gain of Vout EADC sense.

Bit	Description	Format
15:0	Gain of Vout EADC sense.	Direct

**VOUT\_SCALE\_MONITOR (0x2A)**

Description: Normally there is a voltage divider in the voltage sense circuit. The scale factor is represented by VOUT\_SCALE\_MONITOR.

Bit	Description	Format
15:0	Normally there is a voltage divider in the voltage sense circuit. The scale factor is represented by VOUT_SCALE_MONITOR.	Direct

**MAX\_DUTY (0x32)**

Description: Configures the maximum allowed duty-cycle.

Bit	Description	Format	Unit
15:0	Sets the maximum allowable duty cycle of the switching frequency.	Linear	%

**FREQUENCY\_SWITCH (0x33)**

Description: Controls the switching frequency in 1kHz steps.

Bit	Description	Format	Unit
15:0	Sets the switching frequency.	Linear	kHz

**VIN\_ON (0x35)**

Description: The VIN\_ON command sets the value of the input voltage, in volts, at which the unit should start power conversion.

Bit	Description	Format	Unit
15:0	Sets the VIN ON threshold.	Linear	V

**VIN\_OFF (0x36)**

Description: The VIN\_OFF command sets the value of the input voltage, in volts, at which the unit, once operation has started, should stop power conversion.



## Technical Specification

<b>BMR490 series</b> Non-isolated DC-DC Converters Input 40-60 V, Output up to 139 A / 1300 W	28701-BMR490 Rev D	September 2020
	© Flex	

Bit	Description	Format	Unit
15:0	Sets the VIN OFF threshold.	Linear	V

**INTERLEAVE (0x37)**

Description: Configures the phase offset with respect to a common SYNC clock. When multiple product share a common DC input supply, spreading of the switching phases between the products can be utilized. This reduces the input capacitance requirements and efficiency losses, since the peak current drawn from the input supply is effectively spread out over the whole switch period. If two or more units have their outputs connected in parallel, interleaving will reduce ripple currents. This requires that the products are synchronized using the SYNC pin.

Bit	Function	Description	Format
11:8	Group ID Number	Value 0-15. Sets an ID number to a group of interleaved rails.	Integer Unsigned
7:4	Number of Rails	Value 0-15. Sets the number of units in the group, including the SYNC OUT product.	Integer Unsigned
3:0	Rail Position	Value 0-15. Sets the interleave order for this unit. The product configured to SYNC OUT shall be assigned to number 0	Integer Unsigned

**IOUT\_CAL\_OFFSET (0x39)**

Description: Sets the current-sense offset.

Bit	Description	Format	Unit
15:0	Sets an offset to IOUT readings. Use to compensate for delayed measurements of current ramp.	Linear	A

**VOUT\_OV\_FAULT\_LIMIT (0x40)**

Description: Output over voltage fault limit.

Bit	Description	Format	Unit
15:0	Output over voltage fault limit.	Vout Mode Unsigned	V

**VOUT\_OV\_FAULT\_RESPONSE (0x41)**

Description: Output over voltage fault response.

Bit	Function	Description	Value	Function	Description
7:6	Response		00	Ignore Fault	The PMBus device continues operation without interruption.
			01	Perform Retries while Operating	The PMBus device continues operation for the delay time specified by bits [2:0] and the delay time unit specified for that particular fault. If the fault condition is still present at the end of the delay time, the unit responds as programmed in the Retry Setting (bits [5:3]).
			10	Disable and retry	The device shuts down (disables the output) and responds according to the retry setting in bits [5:3].

## Technical Specification

**BMR490 series** Non-isolated DC-DC Converters  
Input 40-60 V, Output up to 139 A / 1300 W

28701-BMR490 Rev D September 2020

© Flex

Bit	Function	Description	Value	Function	Description
		Describes the device interruption operation. 00b - The PMBus device continues operation without interruption. 01b - The PMBus device continues operation for the delay time specified by bits [2:0] and the delay time unit specified for that particular fault. If the fault condition condition is still present at the end of the delay time, the unit responds as programmed in the Retry Setting (bits [5:3]). 10b - The device shuts down (disables the output) and responds according to the Retry Setting in bits [5:3]. 11b - The device's output is disabled while the fault is present. Operation resumes and the output is enabled when the fault condition no longer exists.	11	Disable until Fault Cleared	A fault can cleared in several ways: The bit is individually cleared, The device receives a CLEAR_FAULTS command, a RESET signal (if one exists) is asserted, the output is commanded through the CTRL pin, the OPERATION command, or the combined action of the CTRL pin and OPERATION command, to turn off and then to turn back on, or Bias power is removed from the PMBus device.
5:3	Retries	The device attempts to restart the number of times set by these bits. 000b means the device does not attempt a restart. 111b means the device attempts restarting continuously.	000	Do Not Retry	A zero value for the Retry Setting means that the unit does not attempt to restart. The output remains disabled until the fault is cleared (Section 10.7).
			001	Retry Once	The PMBus device attempts to restart 1 time. If the device fails to restart, it disables the output and remains off until the fault is cleared as described in Section 10.7. The time between the start of each attempt to restart is set by the value in bits [2:] along with the delay time unit specified for that particular fault.
			010	Retry Twice	The PMBus device attempts to restart 2 times. If the device fails to restart, it disables the output and remains off until the fault is cleared as described in Section 10.7. The time between the start of each attempt to restart is set by the value in bits [2:] along with the delay time unit specified for that particular fault.
			011	Retry 3 times	The PMBus device attempts to restart 3 times. If the device fails to restart, it disables the output and remains off until the fault is cleared as described in Section 10.7. The time between the start of each attempt to restart is set by the value in bits [2:] along with the delay time unit specified for that particular fault.

## Technical Specification

**BMR490 series** Non-isolated DC-DC Converters  
Input 40-60 V, Output up to 139 A / 1300 W

28701-BMR490 Rev D September 2020

© Flex

Bit	Function	Description	Value	Function	Description
			100	Retry 4 times	The PMBus device attempts to restart 4 times. If the device fails to restart, it disables the output and remains off until the fault is cleared as described in Section 10.7. The time between the start of each attempt to restart is set by the value in bits [2:] along with the delay time unit specified for that particular fault.
			101	Retry 5 times	The PMBus device attempts to restart 5 times. If the device fails to restart, it disables the output and remains off until the fault is cleared as described in Section 10.7. The time between the start of each attempt to restart is set by the value in bits [2:] along with the delay time unit specified for that particular fault.
			110	Retry 6 times	The PMBus device attempts to restart 6 times. If the device fails to restart, it disables the output and remains off until the fault is cleared as described in Section 10.7. The time between the start of each attempt to restart is set by the value in bits [2:] along with the delay time unit specified for that particular fault.
			111	Retry Continuously	The PMBus device attempts to restart continuously, without limitation, until it is commanded OFF (by the CONTROL pin or OPERATION command or both), bias power is removed, or another fault condition causes the unit to shut down.
2:0	Retry Time and Delay Time	Number of delay time units. Used for either the amount of time the device is to continue operating after a fault is detected or for the amount of time between attempts to restart. The time unit is set in register 0xD2.	0	1	
			1	2	
			2	4	
			3	8	
			4	16	
			5	32	
			6	64	
			7	128	

**VOUT\_OV\_WARN\_LIMIT (0x42)**

Description: Output over voltage warning limit.

Bit	Description	Format	Unit
15:0	Output over voltage warning limit.	Vout Mode Unsigned	V

**VOUT\_UV\_WARN\_LIMIT (0x43)**

Description: Output under voltage warning limit.

Bit	Description	Format	Unit
15:0	Output under voltage warning limit.	Vout Mode Unsigned	V

## Technical Specification

<b>BMR490 series</b> Non-isolated DC-DC Converters Input 40-60 V, Output up to 139 A / 1300 W	28701-BMR490 Rev D	September 2020
	© Flex	

**VOUT\_UV\_FAULT\_LIMIT (0x44)**

Description: Output under voltage fault limit.

Bit	Description	Format	Unit
15:0	Output under voltage fault limit.	Vout Mode Unsigned	V

**VOUT\_UV\_FAULT\_RESPONSE (0x45)**

Description: Output under voltage fault response.

Bit	Function	Description	Value	Function	Description
7:6	Response	Describes the device interruption operation. 00b - The PMBus device continues operation without interruption. 01b - The PMBus device continues operation for the delay time specified by bits [2:0] and the delay time unit specified for that particular fault. If the fault condition is still present at the end of the delay time, the unit responds as programmed in the Retry Setting (bits [5:3]). 10b - The device shuts down (disables the output) and responds according to the Retry Setting in bits [5:3]. 11b - The device's output is disabled while the fault is present. Operation resumes and the output is enabled when the fault condition no longer exists.	00	Ignore Fault	The PMBus device continues operation without interruption.
			01	Perform Retries while Operating	The PMBus device continues operation for the delay time specified by bits [2:0] and the delay time unit specified for that particular fault. If the fault condition is still present at the end of the delay time, the unit responds as programmed in the Retry Setting (bits [5:3]).
			10	Disable and retry	The device shuts down (disables the output) and responds according to the retry setting in bits [5:3].
			11	Disable until Fault Cleared	A fault can be cleared in several ways: The bit is individually cleared, The device receives a CLEAR_FAULTS command, a RESET signal (if one exists) is asserted, the output is commanded through the CTRL pin, the OPERATION command, or the combined action of the CTRL pin and OPERATION command, to turn off and then to turn back on, or Bias power is removed from the PMBus device.
5:3	Retries	The device attempts to restart the number of times set by these bits. 000b means the device does not attempt a restart. 111b means the device attempts restarting continuously.	000	Do Not Retry	A zero value for the Retry Setting means that the unit does not attempt to restart. The output remains disabled until the fault is cleared (Section 10.7).
			001	Retry Once	The PMBus device attempts to restart 1 time. If the device fails to restart, it disables the output and remains off until the fault is cleared as described in Section 10.7. The time between the start of each attempt to restart is set by the value in bits [2:] along with the delay time unit specified for that particular fault.

Technical Specification

<b>BMR490 series</b> Non-isolated DC-DC Converters Input 40-60 V, Output up to 139 A / 1300 W	28701-BMR490 Rev D	September 2020
	© Flex	

Bit	Function	Description	Value	Function	Description
			010	Retry Twice	The PMBus device attempts to restart 2 times. If the device fails to restart, it disables the output and remains off until the fault is cleared as described in Section 10.7. The time between the start of each attempt to restart is set by the value in bits [2:] along with the delay time unit specified for that particular fault.
			011	Retry 3 times	The PMBus device attempts to restart 3 times. If the device fails to restart, it disables the output and remains off until the fault is cleared as described in Section 10.7. The time between the start of each attempt to restart is set by the value in bits [2:] along with the delay time unit specified for that particular fault.
			100	Retry 4 times	The PMBus device attempts to restart 4 times. If the device fails to restart, it disables the output and remains off until the fault is cleared as described in Section 10.7. The time between the start of each attempt to restart is set by the value in bits [2:] along with the delay time unit specified for that particular fault.
			101	Retry 5 times	The PMBus device attempts to restart 5 times. If the device fails to restart, it disables the output and remains off until the fault is cleared as described in Section 10.7. The time between the start of each attempt to restart is set by the value in bits [2:] along with the delay time unit specified for that particular fault.
			110	Retry 6 times	The PMBus device attempts to restart 6 times. If the device fails to restart, it disables the output and remains off until the fault is cleared as described in Section 10.7. The time between the start of each attempt to restart is set by the value in bits [2:] along with the delay time unit specified for that particular fault.
			111	Retry Continuously	The PMBus device attempts to restart continuously, without limitation, until it is commanded OFF (by the CONTROL pin or OPERATION command or both), bias power is removed, or another fault condition causes the unit to shut down.
2:0	Retry Time and Delay Time		0	1	
			1	2	
			2	4	
			3	8	

## Technical Specification

**BMR490 series** Non-isolated DC-DC Converters  
Input 40-60 V, Output up to 139 A / 1300 W

28701-BMR490 Rev D September 2020  
© Flex

Bit	Function	Description	Value	Function	Description
		Number of delay time units. Used for either the amount of time the device is to continue operating after a fault is detected or for the amount of time between attempts to restart. The time unit is set in register 0xD2.	4	16	
			5	32	
			6	64	
			7	128	

**IOUT\_OC\_FAULT\_LIMIT (0x46)**

Description: Output over current limit.

Bit	Description	Format	Unit
15:0	Output over current fault limit.	Linear	A

**IOUT\_OC\_FAULT\_RESPONSE (0x47)**

Description: Output over current fault response.

Bit	Function	Description	Value	Function	Description
7:6	Response	For all values of bits [7:6], the device: Sets the corresponding fault bit in the status registers and If the device supports notifying the host, it does so.	00	Ignore Fault	The PMBus device continues to operate indefinitely while maintaining the output current at the value set by IOUT_OC_FAULT_LIMIT without regard to the output voltage (known as constant-current or brickwall limiting).
			01	Conditioned constant current	The PMBus device continues to operate indefinitely while maintaining the output current at the value set by IOUT_OC_FAULT_LIMIT as long as the output voltage remains above the minimum value specified by IOUT_OC_LV_FAULT_LIMIT. If the output voltage is pulled down to less than that value, then the PMBus device shuts down and responds according to the Retry setting in bits [5:3].
			10	Delay w/ Const. Current & Retry	The PMBus device continues to operate, maintaining the output current at the value set by IOUT_OC_FAULT_LIMIT without regard to the output voltage, for the delay time set by bits [2:0] and the delay time units for specified in the IOUT_OC_FAULT_RESPONSE. If the device is still operating in current limiting at the end of the delay time, the device responds as programmed by the Retry Setting in bits [5:3].
			11	Disable and Retry	The PMBus device shuts down and responds as programmed by the Retry Setting in bits [5:3].

## Technical Specification

**BMR490 series** Non-isolated DC-DC Converters  
Input 40-60 V, Output up to 139 A / 1300 W

28701-BMR490 Rev D September 2020

© Flex

Bit	Function	Description	Value	Function	Description
5:3	Retries	The device attempts to restart the number of times set by these bits. 000b means the device does not attempt a restart. 111b means the device attempts restarting continuously.	000	Do Not Retry	A zero value for the Retry Setting means that the unit does not attempt to restart. The output remains disabled until the fault is cleared (Section 10.7).
			001	Retry Once	The PMBus device attempts to restart 1 time. If the device fails to restart, it disables the output and remains off until the fault is cleared as described in Section 10.7. The time between the start of each attempt to restart is set by the value in bits [2:] along with the delay time unit specified for that particular fault.
			010	Retry Twice	The PMBus device attempts to restart 2 times. If the device fails to restart, it disables the output and remains off until the fault is cleared as described in Section 10.7. The time between the start of each attempt to restart is set by the value in bits [2:] along with the delay time unit specified for that particular fault.
			011	Retry 3 times	The PMBus device attempts to restart 3 times. If the device fails to restart, it disables the output and remains off until the fault is cleared as described in Section 10.7. The time between the start of each attempt to restart is set by the value in bits [2:] along with the delay time unit specified for that particular fault.
			100	Retry 4 times	The PMBus device attempts to restart 4 times. If the device fails to restart, it disables the output and remains off until the fault is cleared as described in Section 10.7. The time between the start of each attempt to restart is set by the value in bits [2:] along with the delay time unit specified for that particular fault.
			101	Retry 5 times	The PMBus device attempts to restart 5 times. If the device fails to restart, it disables the output and remains off until the fault is cleared as described in Section 10.7. The time between the start of each attempt to restart is set by the value in bits [2:] along with the delay time unit specified for that particular fault.

## Technical Specification

**BMR490 series** Non-isolated DC-DC Converters  
Input 40-60 V, Output up to 139 A / 1300 W

28701-BMR490 Rev D September 2020  
© Flex

Bit	Function	Description	Value	Function	Description
			110	Retry 6 times	The PMBus device attempts to restart 6 times. If the device fails to restart, it disables the output and remains off until the fault is cleared as described in Section 10.7. The time between the start of each attempt to restart is set by the value in bits [2:] along with the delay time unit specified for that particular fault.
			111	Retry Continuously	The PMBus device attempts to restart continuously, without limitation, until it is commanded OFF (by the CONTROL pin or OPERATION command or both), bias power is removed, or another fault condition causes the unit to shut down.
2:0	Retry Time and Delay Time	Number of delay time units. Used for either the amount of time the device is to continue operating after a fault is detected or for the amount of time between attempts to restart. The time unit is set in register 0xD2.	0	1	
			1	2	
			2	4	
			3	8	
			4	16	
			5	32	
			6	64	
			7	128	

**IOUT\_OC\_LV\_FAULT\_LIMIT (0x48)**

Description: Set the output over-current low-voltage fault threshold.

Bit	Description	Format	Unit
15:0	Set the output over-current low-voltage fault threshold.	Vout Mode Unsigned	V

**IOUT\_OC\_WARN\_LIMIT (0x4A)**

Description: Output over current warning limit.

Bit	Description	Format	Unit
15:0	Output over current warning limit.	Linear	A

**OT\_FAULT\_LIMIT (0x4F)**

Description: Over temperature fault limit.

Bit	Description	Format	Unit
15:0	Over temperature fault limit.	Linear	°C

**OT\_FAULT\_RESPONSE (0x50)**

Description: Over temperature fault response.

Bit	Function	Description	Value	Function	Description
7:6	Response		00	Ignore Fault	The PMBus device continues operation without interruption.



## Technical Specification

**BMR490 series** Non-isolated DC-DC Converters  
Input 40-60 V, Output up to 139 A / 1300 W

28701-BMR490 Rev D September 2020

© Flex

Bit	Function	Description	Value	Function	Description
			01	Perform Retries while Operating	The PMBus device continues operation for the delay time specified by bits [2:0] and the delay time unit specified for that particular fault. If the fault condition is still present at the end of the delay time, the unit responds as programmed in the Retry Setting (bits [5:3]).
			10	Disable and retry	The device shuts down (disables the output) and responds according to the retry setting in bits [5:3].
			11	Disable until Fault Cleared	A fault can be cleared in several ways: The bit is individually cleared, The device receives a CLEAR_FAULTS command, a RESET signal (if one exists) is asserted, the output is commanded through the CTRL pin, the OPERATION command, or the combined action of the CTRL pin and OPERATION command, to turn off and then to turn back on, or Bias power is removed from the PMBus device.
5:3	Retries		000	Do Not Retry	A zero value for the Retry Setting means that the unit does not attempt to restart. The output remains disabled until the fault is cleared (Section 10.7).
			001	Retry Once	The PMBus device attempts to restart 1 time. If the device fails to restart, it disables the output and remains off until the fault is cleared as described in Section 10.7. The time between the start of each attempt to restart is set by the value in bits [2:] along with the delay time unit specified for that particular fault.
			010	Retry Twice	The PMBus device attempts to restart 2 times. If the device fails to restart, it disables the output and remains off until the fault is cleared as described in Section 10.7. The time between the start of each attempt to restart is set by the value in bits [2:] along with the delay time unit specified for that particular fault.
			011	Retry 3 times	The PMBus device attempts to restart 3 times. If the device fails to restart, it disables the output and remains off until the fault is cleared as described in Section 10.7. The time between the start of each attempt to restart is set by the value in bits [2:] along with the delay time unit specified for that particular fault.

## Technical Specification

**BMR490 series** Non-isolated DC-DC Converters  
Input 40-60 V, Output up to 139 A / 1300 W

28701-BMR490 Rev D September 2020  
© Flex

Bit	Function	Description	Value	Function	Description
			100	Retry 4 times	The PMBus device attempts to restart 4 times. If the device fails to restart, it disables the output and remains off until the fault is cleared as described in Section 10.7. The time between the start of each attempt to restart is set by the value in bits [2:] along with the delay time unit specified for that particular fault.
			101	Retry 5 times	The PMBus device attempts to restart 5 times. If the device fails to restart, it disables the output and remains off until the fault is cleared as described in Section 10.7. The time between the start of each attempt to restart is set by the value in bits [2:] along with the delay time unit specified for that particular fault.
			110	Retry 6 times	The PMBus device attempts to restart 6 times. If the device fails to restart, it disables the output and remains off until the fault is cleared as described in Section 10.7. The time between the start of each attempt to restart is set by the value in bits [2:] along with the delay time unit specified for that particular fault.
			111	Retry Continuously	The PMBus device attempts to restart continuously, without limitation, until it is commanded OFF (by the CONTROL pin or OPERATION command or both), bias power is removed, or another fault condition causes the unit to shut down.
2:0	Retry Time and Delay Time	Number of delay time units. Used for either the amount of time the device is to continue operating after a fault is detected or for the amount of time between attempts to restart. The time unit is set in register 0xD2.	0	1	
			1	2	
			2	4	
			3	8	
			4	16	
			5	32	
			6	64	
			7	128	

**OT\_WARN\_LIMIT (0x51)**

Description: Over temperature warning limit.

Bit	Description	Format	Unit
15:0	Over temperature warning limit.	Linear	°C

**UT\_WARN\_LIMIT (0x52)**

Description: Under temperature warning limit.

Bit	Description	Format	Unit
15:0	Under temperature warning limit.	Linear	°C

**UT\_FAULT\_LIMIT (0x53)**

Description: Under temperature fault limit.

## Technical Specification

**BMR490 series** Non-isolated DC-DC Converters  
Input 40-60 V, Output up to 139 A / 1300 W

28701-BMR490 Rev D September 2020  
© Flex

Bit	Description	Format	Unit
15:0	Under temperature fault limit.	Linear	°C

**UT\_FAULT\_RESPONSE (0x54)**

Description: Under temperature fault response.

Bit	Function	Description	Value	Function	Description
7:6	Response		00	Ignore Fault	The PMBus device continues operation without interruption.
			01	Perform Retries while Operating	The PMBus device continues operation for the delay time specified by bits [2:0] and the delay time unit specified for that particular fault. If the fault condition is still present at the end of the delay time, the unit responds as programmed in the Retry Setting (bits [5:3]).
			10	Disable and retry	The device shuts down (disables the output) and responds according to the retry setting in bits [5:3].
			11	Disable until Fault Cleared	A fault can be cleared in several ways: The bit is individually cleared, The device receives a CLEAR_FAULTS command, a RESET signal (if one exists) is asserted, the output is commanded through the CTRL pin, the OPERATION command, or the combined action of the CTRL pin and OPERATION command, to turn off and then to turn back on, or Bias power is removed from the PMBus device.
5:3	Retries		000	Do Not Retry	A zero value for the Retry Setting means that the unit does not attempt to restart. The output remains disabled until the fault is cleared (Section 10.7).
			001	Retry Once	The PMBus device attempts to restart 1 time. If the device fails to restart, it disables the output and remains off until the fault is cleared as described in Section 10.7. The time between the start of each attempt to restart is set by the value in bits [2:] along with the delay time unit specified for that particular fault.
			010	Retry Twice	The PMBus device attempts to restart 2 times. If the device fails to restart, it disables the output and remains off until the fault is cleared as described in Section 10.7. The time between the start of each attempt to restart is set by the value in bits [2:] along with the delay time unit specified for that particular fault.

## Technical Specification

**BMR490 series** Non-isolated DC-DC Converters  
Input 40-60 V, Output up to 139 A / 1300 W

28701-BMR490 Rev D September 2020  
© Flex

Bit	Function	Description	Value	Function	Description
			011	Retry 3 times	The PMBus device attempts to restart 3 times. If the device fails to restart, it disables the output and remains off until the fault is cleared as described in Section 10.7. The time between the start of each attempt to restart is set by the value in bits [2:] along with the delay time unit specified for that particular fault.
			100	Retry 4 times	The PMBus device attempts to restart 4 times. If the device fails to restart, it disables the output and remains off until the fault is cleared as described in Section 10.7. The time between the start of each attempt to restart is set by the value in bits [2:] along with the delay time unit specified for that particular fault.
			101	Retry 5 times	The PMBus device attempts to restart 5 times. If the device fails to restart, it disables the output and remains off until the fault is cleared as described in Section 10.7. The time between the start of each attempt to restart is set by the value in bits [2:] along with the delay time unit specified for that particular fault.
			110	Retry 6 times	The PMBus device attempts to restart 6 times. If the device fails to restart, it disables the output and remains off until the fault is cleared as described in Section 10.7. The time between the start of each attempt to restart is set by the value in bits [2:] along with the delay time unit specified for that particular fault.
			111	Retry Continuously	The PMBus device attempts to restart continuously, without limitation, until it is commanded OFF (by the CONTROL pin or OPERATION command or both), bias power is removed, or another fault condition causes the unit to shut down.
2:0	Retry Time and Delay Time	Number of delay time units. Used for either the amount of time the device is to continue operating after a fault is detected or for the amount of time between attempts to restart. The time unit is set in register 0xD2.	0 1 2 3 4 5 6 7	1 2 4 8 16 32 64 128	

**VIN\_OV\_FAULT\_LIMIT (0x55)**

Description: Input over voltage fault limit.

Bit	Description	Format	Unit
15:0	Input over voltage fault limit.	Linear	V

## Technical Specification

<b>BMR490 series</b> Non-isolated DC-DC Converters Input 40-60 V, Output up to 139 A / 1300 W	28701-BMR490 Rev D	September 2020
	© Flex	

**VIN\_OV\_FAULT\_RESPONSE (0x56)**

Description: Input over voltage fault response.

Bit	Function	Description	Value	Function	Description
7:6	Response		00	Ignore Fault	The PMBus device continues operation without interruption.
			01	Perform Retries while Operating	The PMBus device continues operation for the delay time specified by bits [2:0] and the delay time unit specified for that particular fault. If the fault condition is still present at the end of the delay time, the unit responds as programmed in the Retry Setting (bits [5:3]).
			10	Disable and retry	The device shuts down (disables the output) and responds according to the retry setting in bits [5:3].
			11	Disable until Fault Cleared	A fault can be cleared in several ways: The bit is individually cleared, The device receives a CLEAR_FAULTS command, a RESET signal (if one exists) is asserted, the output is commanded through the CTRL pin, the OPERATION command, or the combined action of the CTRL pin and OPERATION command, to turn off and then to turn back on, or Bias power is removed from the PMBus device.
5:3	Retries		000	Do Not Retry	A zero value for the Retry Setting means that the unit does not attempt to restart. The output remains disabled until the fault is cleared (Section 10.7).
			001	Retry Once	The PMBus device attempts to restart 1 time. If the device fails to restart, it disables the output and remains off until the fault is cleared as described in Section 10.7. The time between the start of each attempt to restart is set by the value in bits [2:] along with the delay time unit specified for that particular fault.
			010	Retry Twice	The PMBus device attempts to restart 2 times. If the device fails to restart, it disables the output and remains off until the fault is cleared as described in Section 10.7. The time between the start of each attempt to restart is set by the value in bits [2:] along with the delay time unit specified for that particular fault.

## Technical Specification

**BMR490 series** Non-isolated DC-DC Converters  
Input 40-60 V, Output up to 139 A / 1300 W

28701-BMR490 Rev D September 2020

© Flex

Bit	Function	Description	Value	Function	Description
			011	Retry 3 times	The PMBus device attempts to restart 3 times. If the device fails to restart, it disables the output and remains off until the fault is cleared as described in Section 10.7. The time between the start of each attempt to restart is set by the value in bits [2:] along with the delay time unit specified for that particular fault.
			100	Retry 4 times	The PMBus device attempts to restart 4 times. If the device fails to restart, it disables the output and remains off until the fault is cleared as described in Section 10.7. The time between the start of each attempt to restart is set by the value in bits [2:] along with the delay time unit specified for that particular fault.
			101	Retry 5 times	The PMBus device attempts to restart 5 times. If the device fails to restart, it disables the output and remains off until the fault is cleared as described in Section 10.7. The time between the start of each attempt to restart is set by the value in bits [2:] along with the delay time unit specified for that particular fault.
			110	Retry 6 times	The PMBus device attempts to restart 6 times. If the device fails to restart, it disables the output and remains off until the fault is cleared as described in Section 10.7. The time between the start of each attempt to restart is set by the value in bits [2:] along with the delay time unit specified for that particular fault.
			111	Retry Continuously	The PMBus device attempts to restart continuously, without limitation, until it is commanded OFF (by the CONTROL pin or OPERATION command or both), bias power is removed, or another fault condition causes the unit to shut down.
2:0	Retry Time and Delay Time	Number of delay time units. Used for either the amount of time the device is to continue operating after a fault is detected or for the amount of time between attempts to restart. The time unit is set in register 0xD2.	0 1 2 3 4 5 6 7	1 2 4 8 16 32 64 128	

**VIN\_OV\_WARN\_LIMIT (0x57)**

Description: Input over voltage warning limit.

Bit	Description	Format	Unit
15:0	Input over voltage warning limit.	Linear	V

## Technical Specification

<b>BMR490 series</b> Non-isolated DC-DC Converters Input 40-60 V, Output up to 139 A / 1300 W	28701-BMR490 Rev D	September 2020
	© Flex	

**VIN\_UV\_WARN\_LIMIT (0x58)**

Description: Input under voltage warning limit. This command set also the input voltage threshold for the HRR function (Hybrid Ratio Regulation). The HRR function is enabled with command MFR\_SPECIAL\_OPTIONS (0xE0).

Bit	Description	Format	Unit
15:0	Input under voltage warning limit and/or HRR threshold.	Linear	V

**VIN\_UV\_FAULT\_LIMIT (0x59)**

Description: Input under voltage fault limit.

Bit	Description	Format	Unit
15:0	Input under voltage fault limit.	Linear	V

**VIN\_UV\_FAULT\_RESPONSE (0x5A)**

Description: Input under voltage fault response.

Bit	Function	Description	Value	Function	Description
7:6	Response		00	Ignore Fault	The PMBus device continues operation without interruption.
			01	Perform Retries while Operating	The PMBus device continues operation for the delay time specified by bits [2:0] and the delay time unit specified for that particular fault. If the fault condition is still present at the end of the delay time, the unit responds as programmed in the Retry Setting (bits [5:3]).
			10	Disable and retry	The device shuts down (disables the output) and responds according to the retry setting in bits [5:3].
			11	Disable until Fault Cleared	A fault can cleared in several ways: The bit is individually cleared, The device receives a CLEAR_FAULTS command, a RESET signal (if one exists) is asserted, the output is commanded through the CTRL pin, the OPERATION command, or the combined action of the CTRL pin and OPERATION command, to turn off and then to turn back on, or Bias power is removed from the PMBus device.
5:3	Retries		000	Do Not Retry	A zero value for the Retry Setting means that the unit does not attempt to restart. The output remains disabled until the fault is cleared (Section 10.7).
			001	Retry Once	The PMBus device attempts to restart 1 time. If the device fails to restart, it disables the output and remains off until the fault is cleared as described in Section 10.7. The time between the start of each attempt to restart is set by the value in bits [2:] along with the delay time unit specified for that particular fault.

## Technical Specification

**BMR490 series** Non-isolated DC-DC Converters  
 Input 40-60 V, Output up to 139 A / 1300 W

 28701-BMR490 Rev D      September 2020  
 © Flex

Bit	Function	Description	Value	Function	Description
			010	Retry Twice	The PMBus device attempts to restart 2 times. If the device fails to restart, it disables the output and remains off until the fault is cleared as described in Section 10.7. The time between the start of each attempt to restart is set by the value in bits [2:] along with the delay time unit specified for that particular fault.
			011	Retry 3 times	The PMBus device attempts to restart 3 times. If the device fails to restart, it disables the output and remains off until the fault is cleared as described in Section 10.7. The time between the start of each attempt to restart is set by the value in bits [2:] along with the delay time unit specified for that particular fault.
			100	Retry 4 times	The PMBus device attempts to restart 4 times. If the device fails to restart, it disables the output and remains off until the fault is cleared as described in Section 10.7. The time between the start of each attempt to restart is set by the value in bits [2:] along with the delay time unit specified for that particular fault.
			101	Retry 5 times	The PMBus device attempts to restart 5 times. If the device fails to restart, it disables the output and remains off until the fault is cleared as described in Section 10.7. The time between the start of each attempt to restart is set by the value in bits [2:] along with the delay time unit specified for that particular fault.
			110	Retry 6 times	The PMBus device attempts to restart 6 times. If the device fails to restart, it disables the output and remains off until the fault is cleared as described in Section 10.7. The time between the start of each attempt to restart is set by the value in bits [2:] along with the delay time unit specified for that particular fault.
			111	Retry Continuously	The PMBus device attempts to restart continuously, without limitation, until it is commanded OFF (by the CONTROL pin or OPERATION command or both), bias power is removed, or another fault condition causes the unit to shut down.
2:0	Retry Time and Delay Time		0	1	
			1	2	
			2	4	
			3	8	



## Technical Specification

<b>BMR490 series</b> Non-isolated DC-DC Converters Input 40-60 V, Output up to 139 A / 1300 W	28701-BMR490 Rev D	September 2020
	© Flex	

Bit	Function	Description	Value	Function	Description
		Number of delay time units. Used for either the amount of time the device is to continue operating after a fault is detected or for the amount of time between attempts to restart. The time unit is set in register 0xD2.	4	16	
			5	32	
			6	64	
			7	128	

**POWER\_GOOD\_ON (0x5E)**

Description: Sets the output voltage threshold for asserting PG (Power Good).

Bit	Description	Format	Unit
15:0	The POWER_GOOD_ON command sets the output voltage at which an optional POWER_GOOD signal should be asserted.	Vout Mode Unsigned	V

**POWER\_GOOD\_OFF (0x5F)**

Description: If the output voltage is lower than this one, negate power good if power good is enabled through MFR\_MULTI\_PIN\_CONFIG and set the power good bit to 1 in PMBUS status.

Bit	Description	Format	Unit
15:0	If the output voltage is lower than this one, negate power good if power good is enabled through MFR_MULTI_PIN_CONFIG and set the power good bit to 1 in PMBUS status.	Vout Mode Unsigned	V

**TON\_DELAY (0x60)**

Description: Sets the turn-on delay time

Bit	Description	Format	Unit
15:0	Sets the delay time from ENABLE to start of VOUT rise.	Direct	ms

**TON\_RISE (0x61)**

Description: Sets the turn-on transition time.

Bit	Description	Format	Unit
15:0	Sets the rise time of VOUT after ENABLE and TON_DELAY.	Direct	ms

**TON\_MAX\_FAULT\_LIMIT (0x62)**

Description: Sets an upper limit, in milliseconds, on how long the unit can attempt to power up the output without reaching the output undervoltage fault limit.

Bit	Description	Format	Unit
15:0	A value of 0 milliseconds means that there is no limit and that the unit can attempt to bring up the output voltage indefinitely.	Direct	ms

**TON\_MAX\_FAULT\_RESPONSE (0x63)**

Description: Only some of the response types are supported.

Bit	Function	Description	Value	Function	Description
7:6	Response		00	Ignore Fault	The PMBus device continues operation without interruption.
			01	Perform Retries while Operating	The PMBus device continues operation for the delay time specified by bits [2:0] and the delay time unit specified for that particular fault. If the fault condition is still present at the end of the delay time, the unit responds as programmed in the Retry Setting (bits [5:3]).

## Technical Specification

**BMR490 series** Non-isolated DC-DC Converters  
Input 40-60 V, Output up to 139 A / 1300 W

28701-BMR490 Rev D September 2020

© Flex

Bit	Function	Description	Value	Function	Description
			10	Disable and retry	The device shuts down (disables the output) and responds according to the retry setting in bits [5:3].
			11	Disable until Fault Cleared	A fault can be cleared in several ways: The bit is individually cleared, The device receives a CLEAR_FAULTS command, a RESET signal (if one exists) is asserted, the output is commanded through the CTRL pin, the OPERATION command, or the combined action of the CTRL pin and OPERATION command, to turn off and then to turn back on, or Bias power is removed from the PMBus device.
5:3	Retries		000	Do Not Retry	A zero value for the Retry Setting means that the unit does not attempt to restart. The output remains disabled until the fault is cleared (Section 10.7).
			001	Retry Once	The PMBus device attempts to restart 1 time. If the device fails to restart, it disables the output and remains off until the fault is cleared as described in Section 10.7. The time between the start of each attempt to restart is set by the value in bits [2:] along with the delay time unit specified for that particular fault.
			010	Retry Twice	The PMBus device attempts to restart 2 times. If the device fails to restart, it disables the output and remains off until the fault is cleared as described in Section 10.7. The time between the start of each attempt to restart is set by the value in bits [2:] along with the delay time unit specified for that particular fault.
			011	Retry 3 times	The PMBus device attempts to restart 3 times. If the device fails to restart, it disables the output and remains off until the fault is cleared as described in Section 10.7. The time between the start of each attempt to restart is set by the value in bits [2:] along with the delay time unit specified for that particular fault.

## Technical Specification

**BMR490 series** Non-isolated DC-DC Converters  
Input 40-60 V, Output up to 139 A / 1300 W

28701-BMR490 Rev D September 2020  
© Flex

Bit	Function	Description	Value	Function	Description
			100	Retry 4 times	The PMBus device attempts to restart 4 times. If the device fails to restart, it disables the output and remains off until the fault is cleared as described in Section 10.7. The time between the start of each attempt to restart is set by the value in bits [2:] along with the delay time unit specified for that particular fault.
			101	Retry 5 times	The PMBus device attempts to restart 5 times. If the device fails to restart, it disables the output and remains off until the fault is cleared as described in Section 10.7. The time between the start of each attempt to restart is set by the value in bits [2:] along with the delay time unit specified for that particular fault.
			110	Retry 6 times	The PMBus device attempts to restart 6 times. If the device fails to restart, it disables the output and remains off until the fault is cleared as described in Section 10.7. The time between the start of each attempt to restart is set by the value in bits [2:] along with the delay time unit specified for that particular fault.
			111	Retry Continuously	The PMBus device attempts to restart continuously, without limitation, until it is commanded OFF (by the CONTROL pin or OPERATION command or both), bias power is removed, or another fault condition causes the unit to shut down.
2:0	Retry Time and Delay Time	Number of delay time units. Used for either the amount of time the device is to continue operating after a fault is detected or for the amount of time between attempts to restart. The time unit is set in register 0xD2. TON_MAX_FAULT_RESPONSE time unit is referenced to VOUT FAULT time unit.	0 1 2 3 4 5 6 7	1 2 4 8 16 32 64 128	

**TOFF\_DELAY (0x64)**

Description: Sets the turn-off delay.

Bit	Description	Format	Unit
15:0	Sets the delay time from DISABLE to start of VOUT fall.	Direct	ms

**TOFF\_FALL (0x65)**

Description: Sets the turn-off transition time.

Bit	Description	Format	Unit
15:0	Sets the fall time for VOUT after DISABLE and TOFF_DELAY.	Direct	ms

## Technical Specification

<b>BMR490 series</b> Non-isolated DC-DC Converters Input 40-60 V, Output up to 139 A / 1300 W	28701-BMR490 Rev D	September 2020
	© Flex	

**TOFF\_MAX\_WARN\_LIMIT (0x66)**

Description: Sets an upper limit, in milliseconds, on how long the unit can attempt to power down the output without reaching 12.5% of the output voltage programmed at the time the unit is turned off.

Bit	Description	Format	Unit
15:0		Direct	ms

**STATUS\_BYTE (0x78)**

Description: Returns a brief fault/warning status byte.

Bit	Function	Description	Value	Description
6	Off	This bit is asserted if the unit is not providing power to the output, regardless of the reason, including simply not being enabled.	0	No fault
			1	Fault
5	Vout Overvoltage Fault	An output overvoltage fault has occurred.	0	No fault
			1	Fault
4	Iout Overcurrent Fault	An output overcurrent fault has occurred.	0	No fault
			1	Fault
3	Vin Undervoltage Fault	An input undervoltage fault has occurred.	0	No fault
			1	Fault
2	Temperature	A temperature fault or warning has occurred.	0	No fault
			1	Fault
1	Communication/Logic	A communications, memory or logic fault has occurred.	0	No fault
			1	Fault
0	None of the Above	A fault or warning not listed in bits [7:1] has occurred.	0	No fault
			1	Fault

**STATUS\_WORD (0x79)**

Description: Returns an extended fault/warning status byte.

Bit	Function	Description	Value	Description
15	Vout	An output voltage fault or warning has occurred.	0	No fault
			1	Fault
14	Iout/Pout	An output current or output power fault or warning has occurred.	0	No Fault.
			1	Fault.
13	Input	An input voltage, input current, or input power fault or warning has occurred.	0	No Fault.
			1	Fault.
11	Power-Good	The Power-Good signal, if present, is negated.	0	No Fault.
			1	Fault.
6	Off	This bit is asserted if the unit is not providing power to the output, regardless of the reason, including simply not being enabled.	0	No fault
			1	Fault
5	Vout Overvoltage Fault	An output overvoltage fault has occurred.	0	No Fault.
			1	Fault.
4	Iout Overcurrent Fault	An output overcurrent fault has occurred.	0	No Fault.
			1	Fault.
3	Vin Undervoltage Fault	An input undervoltage fault has occurred.	0	No Fault.
			1	Fault.
2	Temperature	A temperature fault or warning has occurred.	0	No Fault.
			1	Fault.
1	Communication/Logic	A communications, memory or logic fault has occurred.	0	No fault.
			1	Fault.
0	None of the Above	A fault or warning not listed in bits [7:1] has occurred.	0	No fault.
			1	Fault.

**STATUS\_VOUT (0x7A)**

Description: Returns Vout-related fault/warning status bits.

Bit	Function	Description	Value	Description
7		Vout Overvoltage Fault.	0	No Fault.

## Technical Specification

**BMR490 series** Non-isolated DC-DC Converters  
Input 40-60 V, Output up to 139 A / 1300 W

28701-BMR490 Rev D September 2020

© Flex

Bit	Function	Description	Value	Description
	Vout Overvoltage Fault		1	Fault.
6	Vout Overvoltage Warning	Vout Overvoltage Warning.	0	No Warning.
			1	Warning.
5	Vout Undervoltage Warning	Vout Undervoltage Warning.	0	No Warning.
			1	Warning.
4	Vout Undervoltage Fault	Vout Undervoltage Fault.	0	No Fault.
			1	Fault.
3	Vout Max Warning	Vout Max Warning (An attempt has been made to set the output voltage to value higher than allowed by the Vout Max command (Section 13.5).	0	No Warning.
			1	Warning.
2	Ton Max Fault	Ton-Max Fault.	0	No Fault
			1	Fault.
1	Toff Max Warning	Toff Max Warning.	0	No Warning.
			1	Warning.

**STATUS\_IOUT (0x7B)**

Description: Returns Iout-related fault/warning status bits.

Bit	Function	Description	Value	Description
7	Iout Overcurrent Fault	Iout Overcurrent Fault.	0	No Fault.
			1	Fault.
6	Iout Overcurrent And Low Voltage Fault	Iout Overcurrent and low voltage fault.	0	No Fault.
			1	Fault.
5	Iout Over Current Warning	Iout Overcurrent Warning.	0	No Warning.
			1	Warning.
4	Iout Undercurrent Fault	Iout Undercurrent Fault.	0	No Fault.
			1	Fault.

**STATUS\_INPUT (0x7C)**

Description: Returns VIN/IIN-related fault/warning status bits.

Bit	Function	Description	Value	Description
7	Vin Overvoltage Fault	Vin Overvoltage Fault.	0	No Fault.
			1	Fault.
6	Vin Overvoltage Warning	VIN Overvoltage Warning.	0	No Warning.
			1	Warning.
5	Vin Undervoltage Warning	Vin Undervoltage Warning.	0	No Warning.
			1	Warning.
4	Vin Undervoltage Fault	Vin Undervoltage Fault.	0	No Fault.
			1	Fault.
3	Insufficient Vin	Asserted when either the input voltage has never exceeded the input turn-on threshold Vin-On, or if the unit did start, the input voltage decreased below the turn-off threshold.	0	No Insufficient VIN encountered yet.
			1	Insufficient Unit is off.

**STATUS\_TEMPERATURE (0x7D)**

Description: Returns the temperature-related fault/warning status bits

Bit	Function	Description	Value	Description
7	Overtemperature Fault	Overtemperature Fault.	0	No Fault.
			1	Fault.
6	Overtemperature Warning	Overtemperature Warning.	0	No Warning.
			1	Warning.
5	Undertemperature Warning	Undertemperature Warning.	0	No Warning.
			1	Warning.
4	Undertemperature Fault	Undertemperature Fault.	0	No Fault.
			1	Fault.

## Technical Specification

<b>BMR490 series</b> Non-isolated DC-DC Converters Input 40-60 V, Output up to 139 A / 1300 W	28701-BMR490 Rev D	September 2020
	© Flex	

**STATUS\_CML (0x7E)**

Description: Returns Communication/Logic/Memory-related fault/warning status bits.

Bit	Function	Description	Value	Description
7	Invalid Or Unsupported Command Received	Invalid Or Unsupported Command Received.	0	No Invalid Command Received.
			1	Invalid Command Received.
6	Invalid Or Unsupported Data Received	Invalid Or Unsupported Data Received.	0	No Invalid Data Received.
			1	Invalid Data Received.
5	Packet Error Check Failed	Packet Error Check Failed.	0	No Failure.
			1	Failure.
4	Memory Fault Detected	Memory Fault Detected.	0	No Fault.
			1	Fault.
1	Other Communication Fault	A communication fault other than the ones listed in this table has occurred.	0	No Fault.
0	Memory Or Logic Fault	Other Memory Or Logic Fault has occurred.	1	Fault.
			0	No Fault.
			1	Fault.
			0	No Fault.

**READ\_VIN (0x88)**

Description: Returns the measured input voltage.

Bit	Description	Format	Unit
15:0	Returns the input voltage reading.	Linear	V

**READ\_VOUT (0x8B)**

Description: Returns the measured output voltage.

Bit	Description	Format	Unit
15:0	Returns the measured output voltage.	Vout Mode Unsigned	V

**READ\_IOUT (0x8C)**

Description: Returns the measured output current.

Bit	Description	Format	Unit
15:0	The device will NACK this command when not enabled and not in the USER_CONFIG monitor mode.	Linear	A

**READ\_TEMPERATURE\_1 (0x8D)**

Description: Returns the measured temperature (internal).

Bit	Description	Format	Unit
15:0		Linear	°C

**READ\_TEMPERATURE\_2 (0x8E)**

Description: Returns the measured temperature (internal).

Bit	Description	Format	Unit
15:0		Linear	°C

**READ\_DUTY\_CYCLE (0x94)**

Description: Returns the measured duty cycle in percent.

Bit	Description	Format	Unit
15:0	Returns the target duty cycle during the ENABLE state. The device will NACK this command when not enabled and not in the USER_CONFIG monitor mode.	Linear	%

## Technical Specification

<b>BMR490 series</b> Non-isolated DC-DC Converters Input 40-60 V, Output up to 139 A / 1300 W	28701-BMR490 Rev D	September 2020
	© Flex	

**READ\_FREQUENCY (0x95)**

Description: Returns the measured SYNC frequency.

Bit	Description	Format	Unit
15:0	Returns the measured operating switch frequency. The device will NACK this command when not enabled and not in the USER_CONFIG monitor mode.	Direct	kHz

**PMBUS\_REVISION (0x98)**

Description: Returns the PMBus revision number for this device.

Bit	Function	Description	Value	Function	Description
7:4	Part I Revision	Part I Revision.	0x0	1.0	Part I Revision 1.0.
			0x1	1.1	Part I Revision 1.1.
			0x2	1.2	Part I Revision 1.2.
			0x3	1.3	Part I Revision 1.3.
3:0	Part II Revision	Part II Revision.	0x0	1.0	Part II Revision 1.0.
			0x1	1.1	Part II Revision 1.1.
			0x2	1.2	Part II Revision 1.2.
			0x3	1.3	Part II Revision 1.3.

**MFR\_ID (0x99)**

Description: Sets the Manufacturers ID

Bit	Description	Format
95:0	Maximum of 12 characters.	ASCII

**MFR\_MODEL (0x9A)**

Description: Sets the MFR MODEL string.

Bit	Description	Format
159:0	Maximum of 20 characters.	ASCII

**MFR\_REVISION (0x9B)**

Description: Sets the MFR revision string.

Bit	Description	Format
95:0	Maximum of 12 characters.	ASCII

**MFR\_LOCATION (0x9C)**

Description: Sets the MFR location string.

Bit	Description	Format
95:0	Maximum of 12 characters.	ASCII

**MFR\_DATE (0x9D)**

Description: This command returns the date the regulator was manufactured.

Bit	Description	Format
95:0	Maximum of 12 characters.	ASCII

**MFR\_SERIAL (0x9E)**

Description: This command returns a string of 13 characters and numbers that provides a unique identification of the regulator.

Bit	Description	Format
159:0	Maximum of 20 characters.	ASCII

**USER\_DATA\_00 (0xB0)**

Description: User data

## Technical Specification

**BMR490 series** Non-isolated DC-DC Converters  
Input 40-60 V, Output up to 139 A / 1300 W

28701-BMR490 Rev D September 2020  
© Flex

Bit	Description	Format
127:0	16 bytes of user data.	ASCII

**MFR\_VIN\_OV\_WARN\_RESPONSE (0xC4)**

Description: Input over voltage Warn response.

Bit	Function	Description	Value	Function	Description
7:6	Response		00	Ignore Fault	The PMBus device continues operation without interruption.
			01	Perform Retries while Operating	The PMBus device continues operation for the delay time specified by bits [2:0] and the delay time unit specified for that particular fault. If the fault condition is still present at the end of the delay time, the unit responds as programmed in the Retry Setting (bits [5:3]).
			10	Disable and retry	The device shuts down (disables the output) and responds according to the retry setting in bits [5:3].
			11	Disable until Fault Cleared	A fault can be cleared in several ways: The bit is individually cleared, The device receives a CLEAR_FAULTS command, a RESET signal (if one exists) is asserted, the output is commanded through the CTRL pin, the OPERATION command, or the combined action of the CTRL pin and OPERATION command, to turn off and then to turn back on, or Bias power is removed from the PMBus device.
5:3	Retries		000	Do Not Retry	A zero value for the Retry Setting means that the unit does not attempt to restart. The output remains disabled until the fault is cleared (Section 10.7).
			001	Retry Once	The PMBus device attempts to restart 1 time. If the device fails to restart, it disables the output and remains off until the fault is cleared as described in Section 10.7. The time between the start of each attempt to restart is set by the value in bits [2:] along with the delay time unit specified for that particular fault.
			010	Retry Twice	The PMBus device attempts to restart 2 times. If the device fails to restart, it disables the output and remains off until the fault is cleared as described in Section 10.7. The time between the start of each attempt to restart is set by the value in bits [2:] along with the delay time unit specified for that particular fault.



## Technical Specification

**BMR490 series** Non-isolated DC-DC Converters  
Input 40-60 V, Output up to 139 A / 1300 W

28701-BMR490 Rev D September 2020  
© Flex

Bit	Function	Description	Value	Function	Description
			011	Retry 3 times	The PMBus device attempts to restart 3 times. If the device fails to restart, it disables the output and remains off until the fault is cleared as described in Section 10.7. The time between the start of each attempt to restart is set by the value in bits [2:] along with the delay time unit specified for that particular fault.
			100	Retry 4 times	The PMBus device attempts to restart 4 times. If the device fails to restart, it disables the output and remains off until the fault is cleared as described in Section 10.7. The time between the start of each attempt to restart is set by the value in bits [2:] along with the delay time unit specified for that particular fault.
			101	Retry 5 times	The PMBus device attempts to restart 5 times. If the device fails to restart, it disables the output and remains off until the fault is cleared as described in Section 10.7. The time between the start of each attempt to restart is set by the value in bits [2:] along with the delay time unit specified for that particular fault.
			110	Retry 6 times	The PMBus device attempts to restart 6 times. If the device fails to restart, it disables the output and remains off until the fault is cleared as described in Section 10.7. The time between the start of each attempt to restart is set by the value in bits [2:] along with the delay time unit specified for that particular fault.
			111	Retry Continuously	The PMBus device attempts to restart continuously, without limitation, until it is commanded OFF (by the CONTROL pin or OPERATION command or both), bias power is removed, or another fault condition causes the unit to shut down.
2:0	Retry Time and Delay Time	Number of delay time units. Used for either the amount of time the device is to continue operating after a fault is detected or for the amount of time between attempts to restart. The time unit is set in register 0xD2.	0 1 2 3 4 5 6 7	1 2 4 8 16 32 64 128	

**MFR\_CONFIG\_UNUSED\_PINS (0xC5)**

Description: Define if pins are used (0) or unused (1). MSB defines if unused pins should be configured as input (0) or output low(1). If an unused pin is defined as input the pin must be grounded. If an unused pin is not grounded it should be defined as output low (mainly for backward compatibility).

## Technical Specification

**BMR490 series** Non-isolated DC-DC Converters  
Input 40-60 V, Output up to 139 A / 1300 W

28701-BMR490 Rev D September 2020  
© Flex

Bit	Function	Description	Value	Function	Description
15	Mfr. FAULT2_CON FIG	If an unused pin is defined as input the pin must be grounded, If an unused pin is not grounded it should be defined as output low.	0	INPUT	
			1	OUTPUT LOW	
14	Mfr. TMS_CONFIG	If an unused pin is defined as input the pin must be grounded, If an unused pin is not grounded it should be defined as output low.	0	INPUT	
			1	OUTPUT LOW	
13	Mfr. TDI_CONFIG	If an unused pin is defined as input the pin must be grounded, If an unused pin is not grounded it should be defined as output low.	0	INPUT	
			1	OUTPUT LOW	
12	Mfr. TDO_CONFIG	If an unused pin is defined as input the pin must be grounded, If an unused pin is not grounded it should be defined as output low.	0	INPUT	
			1	OUTPUT LOW	
11	Mfr. DPWM3B_CO NFIG	If an unused pin is defined as input the pin must be grounded, If an unused pin is not grounded it should be defined as output low.	0	INPUT	
			1	OUTPUT LOW	
10	Mfr. DPWM3A_CO NFIG	If an unused pin is defined as input the pin must be grounded, If an unused pin is not grounded it should be defined as output low.	0	INPUT	
			1	OUTPUT LOW	
9	Mfr. DPWM2B_CO NFIG	If an unused pin is defined as input the pin must be grounded, If an unused pin is not grounded it should be defined as output low.	0	INPUT	
			1	OUTPUT LOW	
8	Mfr. ADC_EXT_TR IG_CONFIG	If an unused pin is defined as input the pin must be grounded, if an unused pin is not grounded it should be defined as output low.	0	INPUT	
			1	OUTPUT LOW	
7	Mfr. Mfr. FAULT2_UTIL IZATION	Define if pin is used or unused. Setting a pin to unused with this command overrides other configurations.	0	USED	
			1	UNUSED	
6	Mfr. Mfr. TMS_UTILIZA TION	Define if pin is used or unused. Setting a pin to unused with this command overrides other configurations.	0	USED	
			1	UNUSED	
5	Mfr. Mfr. TDI_UTILIZAT ION	Define if pin is used or unused. Setting a pin to unused with this command overrides other configurations.	0	USED	
			1	UNUSED	
4	Mfr. Mfr. TDO_UTILIZA TION	Define if pin is used or unused. Setting a pin to unused with this command overrides other configurations.	0	USED	
			1	UNUSED	
3	Mfr. Mfr. DPWM3B_UTI LIZATION	Define if pin is used or unused. Setting a pin to unused with this command overrides other configurations.	0	USED	
			1	UNUSED	
2	Mfr. Mfr. DPWM3A_UTI LIZATION	Define if pin is used or unused. Setting a pin to unused with this command overrides other configurations.	0	USED	
			1	UNUSED	
1	Mfr. Mfr. DPWM2B_UTI LIZATION	Define if pin is used or unused. Setting a pin to unused with this command overrides other configurations.	0	USED	
			1	UNUSED	
0			0	USED	

## Technical Specification

**BMR490 series** Non-isolated DC-DC Converters  
Input 40-60 V, Output up to 139 A / 1300 W

28701-BMR490 Rev D September 2020  
© Flex

Bit	Function	Description	Value	Function	Description
	Mfr. ADC_EXT_TRIG_UTILIZATION	Define if pin is used or unused. Setting a pin to unused with this command overrides other configurations.	1	UNUSED	

**MFR\_RC\_LEVEL (0xC6)**

Description: Set the Remote control threshold when connected to AD03

Bit	Description	Format	Unit
7:0	Sets the level for triggering the Remote control.	Fixed Point Unsigned	V

**MFR\_KS\_PRETRIG (0xC7)**

Description: Value sets the time for pre-trigger a kickstart pulse. Value=0 equals approximately 20us, each unit adds 450ns to this value

Bit	Description	Format	Unit
7:0	Sets the time for pre-trigger a kickstart pulse. Value=0 equals approximately 20us, each unit adds 450ns to this value	Fixed Point Unsigned	us

**MFR\_FAST\_VIN\_OFF\_OFFSET (0xC8)**

Description: Adds an offset to the fast VinOff criteria. The offset value is referenced to VinOff value. This is to shutdown the unit in a controlled fashion when Vin is falling fast.

Bit	Description	Format	Unit
7:0	Adds an offset to the fast VinOff criteria.	Fixed Point Unsigned	V

**MFR\_PGOOD\_POLARITY (0xD0)**

Description: Power good polarity (1:active high; 0: active low).

Bit	Description	Value	Function	Description
7:0	Power good polarity (1:active high; 0: active low).	0x00	Active Low	
		0x01	Active High	

**MFR\_FAST\_OCP\_CFG (0xD1)**

Description: Set the fast OCP threshold

Bit	Function	Description	Format	Unit
12:8	OCP samples	Sets the Number of over current samples before trigger the OCP.	Integer Unsigned	samples
6:0	OCP level	Sets the level for triggering the fast OCP, resolution is in 128 divisions of 2.5V referenced to the maximum readout current.	Integer Unsigned	level

Bit	Function	Description	Value	Function	Description
7	Enable/Disable	Enable or disable Fast OCP	0	Disable	Disables Fast OCP
			1	Enable	Enables Fast OCP

**MFR\_RESPONSE\_UNIT\_CFG (0xD2)**

Description: Defines the basic units 1ms, 10ms, 100ms or 1 sec for each of the four basic responses Vout, Vin, Iout and Temperature. The Configured time is calculated as: Configured time = (Retry Time and Delay Time value in specific Fault response) x (unit in 0xD2)

Bit	Function	Description	Value	Function	Description
7:6	VOUT response delay unit		0	1 ms/unit	
			1	10 ms/unit	
			2	100 ms/unit	

## Technical Specification

**BMR490 series** Non-isolated DC-DC Converters  
Input 40-60 V, Output up to 139 A / 1300 W

28701-BMR490 Rev D September 2020  
© Flex

Bit	Function	Description	Value	Function	Description
		Set the fault response delay unit according to configured delay time for VOUT_OV_FAULT_RESPONSE and VOUT_UV_FAULT_RESPONSE.	3	1 s/unit	
5:4	Vin response delay unit	Set the fault response delay unit according to configured delay time for VIN_OV_FAULT_RESPONSE and VIN_UV_FAULT_RESPONSE.	0	1 ms/unit	
			1	10 ms/unit	
			2	100 ms/unit	
			3	1 s/unit	
3:2	IOUT response delay unit	Set the fault response delay unit according to configured delay time for IOUT_OC_FAULT_RESPONSE and IOUT_OC_FAULT_RESPONSE.	0	1 ms/unit	
			1	10 ms/unit	
			2	100 ms/unit	
			3	1 s/unit	
1:0	Temperature response delay unit	Set the fault response delay unit according to configured delay time for OT_FAULT_RESPONSE and UT_FAULT_RESPONSE.	0	1 ms/unit	
			1	10 ms/unit	
			2	100 ms/unit	
			3	1 s/unit	

**MFR\_VIN\_SCALE\_MONITOR (0xD3)**

Description: Vin Scale Monitor at ON and OFF.

Bit	Function	Description	Format
31:16	Mfr. Vin Scale Monitor on	Trimmed offset at ON	Byte Array
15:0	Mfr. Vin Scale Monitor Off	Trimmed Vin Scale at OFF	Byte Array

**MFR\_PREBIAS\_DVDT\_CFG (0xD4)**

Description: Mfr. prebias dV/dt configuration

Bit	Function	Description	Format	Unit
63:48	Mfr. Maximum allowable positive dVin/dt	This value state the max positive Vin change limit to execute a pre-bias start.	Fixed Point Signed	V/ms
47:32	Mfr. Maximum allowable negative dVin/dt	This value state the max negative Vin change limit to execute a pre-bias start.	Fixed Point Signed	V/ms
31:16	Mfr. Maximum allowable positive dVout/dt	This value state the max positive Vout change limit to execute a pre-bias start.	Fixed Point Signed	V/ms
15:0	Mfr. Maximum allowable negative dVout/dt	This value state the max negative Vout change limit to execute a pre-bias start.	Fixed Point Signed	V/ms

**MFR\_FILTER\_SELECT (0xD5)**

Description: Filter coefficient selection

Bit	Description	Format
7:0	Filter coefficient selection with byte 1: 0 = Vout, 1 = Iout, VFF = 2	Integer Unsigned

## Technical Specification

<b>BMR490 series</b> Non-isolated DC-DC Converters Input 40-60 V, Output up to 139 A / 1300 W	28701-BMR490 Rev D	September 2020
	© Flex	

**MFR\_GET\_SNAPSHOT (0xD7)**

Description: The MFR\_GET\_SNAPSHOT command is a 32-byte read-back of snapshot data values. When input voltage disappears during conversion the Snapshot functionality will automatically store this parametric data to NVM. If the snapshot data contains only FFh except for the counter, it means that the unit ramped up and then was commanded off before input voltage was removed.

Bit	Function	Description	Format	Unit
255:2 40	Snapshot Cycles	Number of shutdown in operation.	Integer Unsigned	Times
239:2 32	Manufacturer Specific Status Byte	Number of faults in previous power cycle.	Byte Array	
231:2 24	Status Other	Status other.	Byte Array	
223:2 16	Status CML	Status CML.	Byte Array	
215:2 08	Status Temperature	Status temperature.	Byte Array	
207:2 00	Status Vin	Status Vin.	Byte Array	
199:1 92	Status Iout	Status Iout.	Byte Array	
191:1 84	Status Vout	Status Vout.	Byte Array	
183:1 76	Status Byte	Status byte.	Byte Array	
175:1 60	Status Word	Status word.	Byte Array	
159:1 44	Time in operation	Duration of previous power cycle in seconds.	Integer Unsigned	seconds
143:1 28	Temperature 2	Read temperature from the temperature sensor not chosen in command 0xDC MFR_SELECT_TEMPERATURE_SENSOR).	Linear	°C
127:1 12	Temperature 1	Read temperature from the temperature sensor chosen in command 0xDC MFR_SELECT_TEMPERATURE_SENSOR).	Linear	°C
111:9 6	Load Current	Load current.	Linear	A
95:80	Output Voltage	Output voltage.	Vout Mode Unsigned	V
79:64	Input Voltage	Input voltage.	Linear	V
63:48	Duty Cycle Old	Duty cycle recorded during normal operation.	Linear	%
47:32	Load Current Old	Load current recorded during normal operation.	Linear	A
31:16	Output Voltage Old	Output voltage recorded during normal operation.	Vout Mode Unsigned	V
15:0	Input Voltage Old	Input voltage recorded during normal operation.	Linear	V

**MFR\_TEMP\_COMPENSATION (0xD8)**

Description: Mfr. temperature compensation parameter

Bit	Function	Description	Format
63:56	Mfr. Temperature compensation deadtime added 2	MFR_TEMP_COMPENSATION_DT_ADD_2 defines the additional dead time used at temperature levels below temperature threshold 2. Unit is nano seconds. It's an unsigned byte, meaning the value can be 0-255.	Byte Array
55:48	Mfr. Temperature compensation deadtime hysteresis 2	MFR_TEMP_COMPENSATION_DT_HYS_2 defines a level for hysteresis i.e. temperature must rise over this level again before dead times are changed.	Byte Array

## Technical Specification

**BMR490 series** Non-isolated DC-DC Converters  
Input 40-60 V, Output up to 139 A / 1300 W

28701-BMR490 Rev D September 2020

© Flex

Bit	Function	Description	Format
47:40	Mfr. Temperature compensation deadline threshold 2	It is a signed byte with the temperature as an integer (°C). This defines a second temperature level for temperature compensation of dead times.	Byte Array
39:32	Mfr. Temperature compensation deadline added 1	MFR_TEMP_COMPENSATION_DT_ADD_1 defines the additional dead time used at temperature levels below temperature threshold 1. Unit is nano seconds. It's an unsigned byte, meaning the value can be 0-255.	Byte Array
31:24	Mfr. Temperature compensation deadline hysteresis 1	MFR_TEMP_COMPENSATION_DT_HYS_1 defines a level for hysteresis i.e. temperature must rise over this level again before dead times are changed.	Byte Array
23:16	Mfr. Temperature compensation deadline threshold 1	It is a signed byte with the temperature as an integer (°C). This defines the first temperature level for temperature compensation of dead times.	Byte Array
15:8	Mfr. Temperature compensation EDAC slope	The second byte, TEMPERATURE_COMPENSATION_EDAC_SLOPE, sets the slope of the temperature compensation taking place above the EDAC_TEMP_COMP_TRESHOLD level. This is a signed byte in Q8 format. The unit is LSB/°C/256. Example: First byte represent 40°C so EDAC_TEMP_COMP_TRESHOLD = 40. Compensate EDAC with 25mV from 40°C to 120°C. The resolution is $1.6V/1024 = 1.56mV / LSB$ . To compensate for the 25mV droop over 80°C we need to add $25/80 = 0.3125mV/°C = 0.3125/1.56 LSB/°C = 0.2 LSB/°C$ to the reference DAC. $0.2*256 = 51$ so EDAC_TEMP_COMP_SLOPE = 51	Byte Array
7:0	Mfr. Temperature compensation EDAC threshold	The first byte in the block is EDAC_TEMP_COMP_TRESHOLD. This defines the level where the temperature compensation shall begin. It is a signed byte with the temperature as an integer (°C). Example: First byte represent 40°C so EDAC_TEMP_COMP_TRESHOLD = 40. Compensate EDAC with 25mV from 40°C to 120°C. The resolution is $1.6V/1024 = 1.56mV / LSB$ . To compensate for the 25mV droop over 80°C we need to add $25/80 = 0.3125mV/°C = 0.3125/1.56 LSB/°C = 0.2 LSB/°C$ to the reference DAC. $0.2*256 = 51$ so EDAC_TEMP_COMP_SLOPE = 51	Byte Array

**MFR\_SET\_ROM\_MODE (0xD9)**

Description: Sends system into ROM mode. Issue this command before attempting to download new firmware to the controller.

Bit	Description	Format
31:0	Sends system into ROM mode. Issue this command before attempting to download new firmware to the controller.	ASCII

**MFR\_ISHARE\_THRESHOLD (0xDA)**

Description: Mfr. current sharing threshold level

Bit	Function	Description	Format	Unit
31:24	Trim limit	Set the trim limit for output voltage. This limit the output voltage to be trimmed to a certain level to prevent max-trim if the controller sense erroneous current.	Integer Unsigned	1.7mv /LSB
15:8	Positive threshold level	Set the threshold level where the output voltage is incremental trimmed to achieve current balance between paralleled device. The threshold level represent at what current level the output voltage start increasing. The hysteresis where no current balancing through CTRL pin is done is between the positive and negative threshold levels.	Integer Unsigned	~50m A/LSB

## Technical Specification

**BMR490 series** Non-isolated DC-DC Converters  
Input 40-60 V, Output up to 139 A / 1300 W

28701-BMR490 Rev D September 2020

© Flex

Bit	Function	Description	Format	Unit
7:0	Negative threshold level	Set the threshold level where the output voltage is decremental trimmed to achieve current balance between paralleled device. The threshold level represent at what current level the output voltage start decreasing. The hysteresis where no current balancing through CTRL pin is done is between the positive and negative threshold levels.	Integer Unsigned	~50m A/LS B

Bit	Function	Description	Value	Function	Description
56	Enable/Disable	Enable or disable Active Current share	0	Disable	Disables active current share
			1	Enable	Enables active current share

**MFR\_GET\_RAMP\_DATA (0xDB)**

Description: The command MFR\_GET\_RAMP\_DATA 0xDB retrieves 32 bytes of ramp data. 15 pairs of instant values of Vin and Vout are recorded during ramp and the interval is adjusted to the ramp time. The record counter value is recorded just before ramp. The record value is equal to last value of "snap shot cycles" + 1. This way it can be judged whether the ramp data was recorded before or after snap shot data. Only the first ramp in a power cycle will be recorded. Data is reset after a successful ramp up.

Bit	Function	Description	Format	Unit
255:248	Vout 14		Integer Unsigned	V
247:240	Vin 14		Integer Unsigned	V
239:232	Vout 13		Integer Unsigned	V
231:224	Vin 13		Integer Unsigned	V
223:216	Vout 12		Integer Unsigned	V
215:208	Vin 12		Integer Unsigned	V
207:200	Vout 11		Integer Unsigned	V
199:192	Vin 11		Integer Unsigned	V
191:184	Vout 10		Integer Unsigned	V
183:176	Vin 10		Integer Unsigned	V
175:168	Vout 9		Integer Unsigned	V
167:160	Vin 9		Integer Unsigned	V
159:152	Vout 8		Integer Unsigned	V
151:144	Vin 8		Integer Unsigned	V
143:136	Vout 7		Integer Unsigned	V
135:128	Vin 7		Integer Unsigned	V
127:120	Vout 6		Integer Unsigned	V
119:112	Vin 6		Integer Unsigned	V
111:104	Vout 5		Integer Unsigned	V
103:96	Vin 5		Integer Unsigned	V
95:88	Vout 4		Integer Unsigned	V

## Technical Specification

**BMR490 series** Non-isolated DC-DC Converters  
Input 40-60 V, Output up to 139 A / 1300 W

28701-BMR490 Rev D September 2020  
© Flex

Bit	Function	Description	Format	Unit
87:80	Vin 4		Integer Unsigned	V
79:72	Vout 3		Integer Unsigned	V
71:64	Vin 3		Integer Unsigned	V
63:56	Vout 2		Integer Unsigned	V
55:48	Vin 2		Integer Unsigned	V
47:40	Vout 1		Integer Unsigned	V
39:32	Vin 1		Integer Unsigned	V
31:24	Vout 0		Integer Unsigned	V
23:16	Vin 0		Integer Unsigned	V
15:0	Counter		Integer Unsigned	Times

**MFR\_SELECT\_TEMPERATURE\_SENSOR (0xDC)**

Description: Select which temperature sensor, internal one or external remote temperature sensor, is used.

Bit	Description	Value	Function	Description
0	Select which temperature sensor, internal one or external remote temperature sensor, is used.	0	Internal IC Sensor	Internal IC temperature sensor selected.
		1	External Sensor	External remote temperature sensor selected.

**MFR\_VIN\_OFFSET (0xDD)**

Description: Vin offset at ON and OFF.

Bit	Function	Description	Format
31:16	Mfr. Vin Offset on	Trimmed offset at ON	Byte Array
15:0	Mfr. Vin Offset off	Trimmed offset at OFF	Byte Array

**MFR\_VOUT\_OFFSET\_MONITOR (0xDE)**

Description: Output voltage trim

Bit	Description	Format	Unit
15:0	Output voltage trim	Vout Mode Signed	V

**MFR\_GET\_STATUS\_DATA (0xDF)**

Description: The command MFR\_GET\_STATUS\_DATA 0xDF retrieves 32 bytes consisting of status words. The recording starts just after ramp has finished and continues during the first 128s after start up (16status word, 8s interval).

Bit	Function	Description	Format
255:240	Status Word 15	Status word 15.	Byte Array
239:224	Status Word 14	Status word 14.	Byte Array
223:208	Status Word 13	Status word 13.	Byte Array
207:192	Status Word 12	Status word 12.	Byte Array



## Technical Specification

**BMR490 series** Non-isolated DC-DC Converters  
Input 40-60 V, Output up to 139 A / 1300 W

28701-BMR490 Rev D September 2020  
© Flex

Bit	Function	Description	Format
191:1 76	Status Word 11	Status word 11.	Byte Array
175:1 60	Status Word 10	Status word 10.	Byte Array
159:1 44	Status Word 9	Status word 9.	Byte Array
143:1 28	Status Word 8	Status word 8.	Byte Array
127:1 12	Status Word 7	Status word 7.	Byte Array
111:9 6	Status Word 6	Status word 6.	Byte Array
95:80	Status Word 5	Status word 5.	Byte Array
79:64	Status Word 4	Status word 4.	Byte Array
63:48	Status Word 3	Status word 3.	Byte Array
47:32	Status Word 2	Status word 2.	Byte Array
31:16	Status Word 1	Status word 1.	Byte Array
15:0	Status Word 0	Status word 0.	Byte Array

**MFR\_SPECIAL\_OPTIONS (0xE0)**

Description: Special option configuration. Bit 0 - Reserved Bit 1 - Reserved Bit 2 - DBV: 0:Disabled 1:Enabled Bit 3 - ART/DLC: 0:Disabled 1:Enabled Bit 5 - DLS: 0:Linear droop 1:Non-linear droop Bit 6 - HRR: 0:Disabled 1:Enabled Bit 7 - Require PEC

Bit	Function	Description	Value	Function	Description
7	Require Packet Error Check	Enables/Disables Packet Error Check.	0		Disabled
			1		Enabled
6	Enable HRR, (Hybrid Regulated Ratio)	Enables the HRR, Hybrid Regulated Ratio. This enables the unit to have a duty cycle head room where max duty cycle is avoided.§ The output voltage will follow the input voltage ratio, below the HRR threshold set in command VIN_UV_WARN_LIMIT (0x58).	0		Disabled
			1		Enabled
5	DLS slope configuration	Setup how the slope of the Vout droop is configured, with linear or non-linear droop.	0	Linear droop	Configured with linear droop
			1	Non-linear droop	Configured with non-linear droop
3	Enable ART/DLC, (Adaptive Ramp-up Time, Dynamic Loop Compensation)	Enables/Disables ART/DLC.	0		Disabled
			1		Enabled
2	Enable DBV, (Dynamic Bus Voltage)	Enables/Disables DBV.	0		Disabled
			1		Enabled

**MFR\_TEMP\_OFFSET\_INT (0xE1)**

Description: Internal temperature offset.

Bit	Description	Format	Unit
15:0	Integer [0.1 °C]	Direct	°C

**MFR\_REMOTE\_TEMP\_CAL (0xE2)**

Description: External temperature offset and slope.

## Technical Specification

<b>BMR490 series</b> Non-isolated DC-DC Converters Input 40-60 V, Output up to 139 A / 1300 W	28701-BMR490 Rev D	September 2020
	© Flex	

Bit	Description	Format
31:0	$T(C) = \text{slope} \times \text{ADC}(v) + \text{offset}$ , Byte 0 byte 1: offset, Byte 2 byte 3: slope.	Byte Array

**MFR\_REMOTE\_CTRL (0xE3)**

Description: Primary Remote Control (RC pin) configuration.

Bit	Function	Description	Value	Function	Description
4	CTRL pin Interaction		0	OR'ed w/ CTRL pin	PriRC is OR:ed with OPERATION and CTRL pin.
			1	AND'ed w/ CTRL pin	PriRC is AND:ed with OPERATION and CTRL pin.
2	Remote CTRL pin Enabled	PriRC Pin Enable: 0:Disabled 1:Enabled	0	Disabled	
			1	Enabled	
1	Remote CTRL pin Polarity	PriRC Polarity: 0:Active High 1:Active Low	0	Active Low	
			1	Active High	
0	Remote Ctrl On/Off	Primary Remote Control (RC Pin) configuration. Bit 0 - PriRC Disable Mode: 0:Soft-Stop 1:Quick Off	0	Soft Stop	Pre-configured ramp down time set TOFF FALL.
			1	Quick Off	Disables the output immediately.

**MFR\_VFF\_PARAMS (0xE6)**

Description: This function is dependent of voltage levels internal to the control IC. It is not recommended to change the parameters Extra compensation, Vin stable threshold and Reference DAC threshold.

Bit	Function	Description	Format
31:24	Extra compensation threshold	Set a threshold where extra compensation of the VFF response is needed. The extra compensation cut the duty cycle with 50% during one period. Too low threshold creates false triggering with noisy output voltage.	Integer Unsigned
23:16	Vin stable threshold	Set a threshold where the input voltage is considered stable and a ready for new VFF response	Integer Unsigned
15:8	Reference DAC fast recover threshold	Below this threshold the reference DAC is adjusted one LSB each interrupt (~27us) otherwise it is adjusted 3 LSB.	Integer Unsigned

Bit	Function	Description	Value	Description
0	Enable VFF, (Voltage Feed Forward)		0	Disabled
			1	Enabled

**MFR\_TEMP\_COEFF (0xE7)**

Description: Temperature coefficient

Bit	Function	Description	Format	Unit
47:40	Mfr. Temp level 2 Comp Factor	The temperature compensation factor for current sense above temperature level 2, used to compensate IOUT_READ value.	Integer Unsigned	
39:32	Mfr. Temp level 2 Comp	The second temperature level used to compensate IOUT_READ.	Integer Unsigned	°C
31:24	Mfr. Temp level 1 Comp Factor	The temperature compensation factor for current sense above temperature level 1, used to compensate IOUT_READ value.	Integer Unsigned	
23:16	Mfr. Temp level 1 Comp	The first temperature level used to compensate IOUT_READ.	Integer Unsigned	°C
15:0	Mfr. Temp Coeff Cu	The temperature coefficient for copper.	Direct	

**MFR\_FILTER\_COEFF (0xE8)**

Description: Mfr. filter coefficients

## Technical Specification

**BMR490 series** Non-isolated DC-DC Converters  
Input 40-60 V, Output up to 139 A / 1300 W

28701-BMR490 Rev D September 2020  
© Flex

Bit	Function	Description	Format
215:2 11	CLA scale	Filter Misc Gain Coefficient: CLA SCALE	Integer Unsigned
210:2 08	yn scale	Filter Misc Gain Coefficient: YN SCALE	Integer Unsigned
207:1 92	kcomp	Filter Misc Gain Coefficient: KCOMP	Integer Unsigned
191:1 76	KD alpha [1]	Filter Coefficient: KD alpha [1]	Integer Unsigned
175:1 60	KD alpha [0]	Filter Coefficient: KD alpha [0]	Integer Unsigned
159:1 44	KD coef [2]	Filter Coefficient: KD coef [2]	Integer Unsigned
143:1 28	KD coef [1]	Filter Coefficient: KD coef [1]	Integer Unsigned
127:1 12	KD coef [0]	Filter Coefficient: KD coef [0]	Integer Unsigned
111:9 6	KI coef [3]	Filter Coefficient: KI coef [3]	Integer Unsigned
95:80	KI coef [2]	Filter Coefficient: KI coef [2]	Integer Unsigned
79:64	KI coef [1]	Filter Coefficient: KI coef [1]	Integer Unsigned
63:48	KI coef [0]	Filter Coefficient: KI coef [0]	Integer Unsigned
47:32	KP coef [2]	Filter Coefficient: KP coef [2]	Integer Unsigned
31:16	KP coef [1]	Filter Coefficient: KP coef [1]	Integer Unsigned
15:0	KP coef [0]	Filter Coefficient: KP coef [0]	Integer Unsigned

**MFR\_FILTER\_NLR\_GAIN (0xE9)**

Description: Mfr. filter nlrains

Bit	Function	Description	Format
121:1 20	AFE Gain	AFE gain	Integer Unsigned
95:80	limit5	Filter Coefficient: LIMIT 5	Integer Unsigned
79:64	limit4	Filter Coefficient: LIMIT 4	Integer Unsigned
63:48	limit3	Filter Coefficient: LIMIT 3	Integer Unsigned
47:32	limit2	Filter Coefficient: LIMIT 2	Integer Unsigned
31:16	limit1	Filter Coefficient: LIMIT 1	Integer Unsigned
15:0	limit0	Filter Coefficient: LIMIT 0	Integer Unsigned

Bit	Function	Description	Value	Function	Description
127:1 25	Bin Configuration (6)	Bin Configuration (6)	0	Coef [0]	
			1	Coef [1]	
			2	Coef [2]	
			3	Coef [3]	
			4	Coef [4]	
			5	Coef [5]	
			6	Coef [6]	
124	Bin Alpha (6)	Bin Alpha (6)			
123	NL Mode	NL Mode			
122	Auto Gear Shift	Auto Gear Shift			
119:1 17	Bin Configuration (4)	Bin Configuration (4)	0	Coef [0]	
			1	Coef [1]	
			2	Coef [2]	
			3	Coef [3]	
			4	Coef [4]	
			5	Coef [5]	
			6	Coef [6]	
116	Bin Alpha (4)	Bin Alpha (4)			
115:1 13		Bin Configuration (5)	0	Coef [0]	
			1	Coef [1]	

## Technical Specification

**BMR490 series** Non-isolated DC-DC Converters  
Input 40-60 V, Output up to 139 A / 1300 W

28701-BMR490 Rev D September 2020

© Flex

Bit	Function	Description	Value	Function	Description
	Bin Configuration (5)		2	Coef [2]	
			3	Coef [3]	
			4	Coef [4]	
			5	Coef [5]	
			6	Coef [6]	
112	Bin Alpha (5)	Bin Alpha (5)			
111:109	Bin Configuration (2)	Bin Configuration (2)	0	Coef [0]	
			1	Coef [1]	
			2	Coef [2]	
			3	Coef [3]	
			4	Coef [4]	
			5	Coef [5]	
108	Bin Alpha (2)	Bin Alpha (2)			
107:105	Bin Configuration (3)	Bin Configuration (3)	0	Coef [0]	
			1	Coef [1]	
			2	Coef [2]	
			3	Coef [3]	
			4	Coef [4]	
			5	Coef [5]	
104	Bin Alpha (3)	Bin Alpha (3)			
103:101	Bin Configuration (0)	Bin Configuration (0)	0	Coef [0]	
			1	Coef [1]	
			2	Coef [2]	
			3	Coef [3]	
			4	Coef [4]	
			5	Coef [5]	
100	Bin Alpha (0)	Bin Alpha (0)			
99:97	Bin Configuration (1)	Bin Configuration (1)	0	Coef [0]	
			1	Coef [1]	
			2	Coef [2]	
			3	Coef [3]	
			4	Coef [4]	
			5	Coef [5]	
96	Bin Alpha (1)	Bin Alpha (1)			

**MFR\_MIN\_DUTY (0xEB)**

Description: Set the minimum duty cycle and minimum deadtime at min duty.

Bit	Function	Description	Format	Unit
15:8	Mfr. Min duty		Integer Unsigned	ns
7:0	Mfr. Minimum deadtime		Integer Unsigned	ns

**MFR\_ACTIVE\_CLAMP (0xEC)**

Description: Active clamp

Bit	Function	Description	Format	Unit
14:8	Mfr. pulse delay	Set the delay of the pulse to the active clamp.	Integer Unsigned	x4 ns
7:0	Mfr. pulse width	Set the pulse width to the active clamp.	Integer Unsigned	x4 ns

## Technical Specification

<b>BMR490 series</b> Non-isolated DC-DC Converters Input 40-60 V, Output up to 139 A / 1300 W	28701-BMR490 Rev D	September 2020
	© Flex	

Bit	Function	Description	Value	Function	Description
15	Active Clamp mode	Set the mode of the active clamp, 1x frequency A and B output inverted outputs phase/2x frequency on A only non-inverted	0	1x frequency inverted	Set 1x frequency inverted
			1	2x frequency non-inverted	Set 2x frequency non-inverted

**MFR\_OFFSET\_ADDRESS (0xEE)**

Description: Value (n) add an offset to the address on SA0 pin when SA1 pin on the digital connector is used for synchronisation.

Bit	Description	Format	Unit
7:0		Integer Unsigned	n + SA0

**MFR\_DBV\_CONFIG (0xEF)**

Description: Configuration of Dynamic Bus Voltage.

Bit	Function	Description	Format	Unit
47:40	Iout Level mid to high	Iout level mid to high transition.	Fixed Point Unsigned	A
39:32	Iout Level high to mid	Iout level high to mid transition.	Fixed Point Unsigned	A
31:24	Output Voltage Mid	Output Voltage Mid.	Fixed Point Unsigned	V
23:16	Iout Level low to mid	Iout level low to mid transition.	Fixed Point Unsigned	A
15:8	Iout Level mid to low	Iout level mid to low transition.	Fixed Point Unsigned	A
7:0	Output Voltage Low	Output Voltage Low.	Fixed Point Unsigned	V

**MFR\_DEBUG\_BUFF (0xF0)**

Description: Output contents in debug\_buf.

Bit	Description	Format
63:0	Output contents in debug_buf.	Byte Array

**MFR\_SETUP\_PASSWORD (0xF1)**

Description: Once a valid new password is sent, the security is turned on.

Bit	Description	Format
95:0	A write is current password (6 bytes, default "000000000000") + new password (6 bytes) A read returns: 0x0000000000000000000000000000 if security is off 0x0000000000000000000000000001 if security is on 0x0000000000000000000000000002 if security setup is locked up due to incorrect password entry	ASCII

**MFR\_DISABLE\_SECURITY\_ONCE (0xF2)**

Description: When security is on, this command is used to temporarily disable the security before the next power reset of the digital PWM controller so that a host can send any command that is either write-protected or sendbyte-protected based on a security bit mask. When security is off, this command will be NACKed.

Bit	Description	Format
47:0	A write is current password (after it was set up with MFR_SETUP_PASSWORD).	ASCII

**MFR\_SECURITY\_BIT\_MASK (0xF4)**

Description: This command is used to individually enable or disable security feature for a write-protectable or sendbyte-protectable PMBUS command.

## Technical Specification

<b>BMR490 series</b> Non-isolated DC-DC Converters Input 40-60 V, Output up to 139 A / 1300 W	28701-BMR490 Rev D	September 2020
	© Flex	

Bit	Description	Format
255:0	When protection is enabled for a PMBUS command and when security is on, the PMBUS command is write-protected or send- byte-protected.	Byte Array

**MFR\_TRANSFORMER\_TURN (0xF5)**

Description: Transformer turn ratio.

Bit	Function	Description	Format
7:4	Mfr. Primary Turn	Number of turn on the primary side of transformer.	Integer Unsigned
3:0	Mfr. secondary Turn	Number of turn on the secondary side of transformer.	Integer Unsigned

**MFR\_OSC\_TRIM (0xF6)**

Description: Internal clock frequency trim value

Bit	Description	Format
7:0	Internal clock frequency trim value.	Integer Unsigned

**MFR\_DLC\_CONFIG (0xF7)**

Description: Configuration of Dynamic Loop Compensation at start up.

Bit	Function	Description	Format	Unit
63:56	Ramp Factor 3, (K3)	Ramp factor for third limit. The value in Ramp Factor 3 is multiplied with the TON_RISE value, to calculate a new TON_RISE slope. The new calculated slope will immediately act as TON_RISE	Fixed Point Signed	
55:48	Third Limit	Third limit for adjustment. When the capacitance estimation reaches over the third limit RAMP_FACTOR_3 is used and the PID setting in Bank 3 is chosen. To change PID settings in Bank 3, 0xD5 must be set to 0x03 after that 0xE8 and 0xE9 can be adjusted.	Fixed Point Signed	mF
47:40	Ramp Factor 2, (K2)	Ramp factor for second limit. The value in Ramp Factor 2 is multiplied with the TON_RISE value, to calculate a new TON_RISE slope. The new calculated slope will immediately act as TON_RISE	Fixed Point Signed	
39:32	Second Limit	Second limit for adjustment. When the capacitance estimation reach over the second limit RAMP_FACTOR_2 is used.	Fixed Point Signed	mF
31:24	Ramp Factor 1, (K1)	Ramp factor for first limit. The value in Ramp Factor 1 is multiplied with the TON_RISE value, to calculate a new TON_RISE slope. The new calculated slope will immediately act as TON_RISE	Fixed Point Signed	
23:16	First Limit	First limit for adjustment. When the capacitance estimation reach over the first limit RAMP_FACTOR_1 is used.	Fixed Point Signed	mF
15:8	Voltage End	Set the end level on the Vout ramp ON for the output cap estimation measurement.	Fixed Point Signed	V
7:0	Voltage Start	Set the start and end levels on the Vout ramp ON for the output cap estimation measurement.	Fixed Point Signed	V

**MFR\_ILIM\_SOFTSTART (0xF8)**

Description: During soft start ILIM is more than the user setting. The value set in this command is in % added ILIM.

Bit	Description	Format	Unit
7:0		Integer Unsigned	%

**MFR\_MULTI\_PIN\_CONFIG (0xF9)**

Description: The MFR\_MULTI\_PIN\_CONFIG command can be re-configured to enable or disable different functions and set the pin configuration of the digital header (K400) (pin 6-15).

Bit	Function	Description	Value	Function	Description
6:5	Sync Mode		00	Disabled	

## Technical Specification

**BMR490 series** Non-isolated DC-DC Converters  
Input 40-60 V, Output up to 139 A / 1300 W

28701-BMR490 Rev D September 2020  
© Flex

Bit	Function	Description	Value	Function	Description
		These bits enables or disables the SYNC function. When enabling choose between SYNC OUT or SYNC IN.	01	Sync in	When the product is configured to SYNC in it will synchronize its switching frequency to the product configured as SYNC out. The switching phases can be spread individually using the INTERLEAVE command 0x37
			10	Sync out	When the product is configured to SYNC out it will send out a SYNC signal that BMR90 products can connect its SYNC in pin. Only 1 product i a group can be configured to SYNC out.
3	SA1 as Sync	Change function of Pin 9 on the digital header (K400). This pin can be used as SA1 or SYNC in/out	0	SA1 normal	Pin 9 configured to set the PMBus address with a resistor connected to pin 9
			1	SA1 as Sync	Pin 9 configured to be used as SYNC input/output
2	Power Good Enable	This bit enable or disable the Power Good function	0	Disabled	
			1	Enabled	
1	Power Good Output	Two output options is available for Power Good output, it is Push/Pull or Open Drain	0	Push/Pull	Power Good configured Push/Pull
			1	Open Drain	Power Good configured Open Drain
0	CTRL Internal Resistor	Using CTRL internal resistor can be useful if no external pull up or pull down resistor exist or no Digital header (K400) is mounted.	0	Disabled	
			1	Enabled	

**MFR\_ADDED\_DROOP\_DURING\_RAMP (0xFC)**

Description: Set an added droop during ramp.

Bit	Description	Format	Unit
15:0	Sets an added effective load line (V/I slope) for the rail in which the device is used, during ramp up.	Linear	mV/A

**MFR\_FIRMWARE\_DATA (0xFD)**

Description: This is a 20-byte block that contains device ID and versions of the firmware.

Bit	Description	Format
159:0	This is a 20-byte block that contains device ID and versions of the firmware.	Byte Array

**MFR\_RESTART (0xFE)**

Description: Writing the string "ERIC" to this command code forces the unit to restart.

Bit	Description	Format
31:0		ASCII