

PIM 4006 SD series Power Interface Module
 Input 36-60 V, Output up to 10.3 A / 100-400 W

28701-BMR45530 Rev D November 2017
 © Flex

Key Features

- Industry standard low profile Sixteenth-brick 33.0 x 22.9 x 8.0 mm (1.3 x 0.9 x 0.315 in.)
- Output over current protection
- Dual power feeds input
- Reverse polarity protection
- Monitoring via I²C/PMBus
- MTBF 2.24 Mh

General Characteristics

- Narrow board pitch applications (15 mm/0.6 in)
- ORing function and Power Good
- Voltage and Current measurement for each feed
- Inrush protection and hot swap functionality
- Failure detection on ORing and hot-swap functions
- Output short-circuit protection
- Designed to work together with an external hold-up capacitor
- Highly automated manufacturing ensures quality ISO 9001/14001 certified supplier



Safety Approvals



Design for Environment



Meets requirements in high-temperature lead-free soldering processes.

Contents

Ordering Information	2
General Information	2
Safety Specification	3
Absolute Maximum Ratings	4
Electrical Specification	
2.56 A / 100 W	PIM 41066
5.12 A / 200 W	PIM 42066
7.69 A / 300 W	PIM 43066
10.3 A / 400 W	PIM 44066
Operating information	11
Thermal Consideration	13
Connections	14
Mechanical Information	18
Soldering Information	19
Delivery Package Information	20
Product Qualification Specification	21

Technical Specification

PIM 4006 SD series Power Interface Module
Input 36-60 V, Output up to 10.3 A / 100-400 W

28701-BMR45530 Rev D November 2017

© Flex

Ordering Information

Product program	Output
PIM 4106	2.56 A / 100 W
PIM 4206	5.12 A / 200 W
PIM 4306	7.69 A / 300 W
PIM 4406	10.3 A / 400 W

Product number and Packaging

PIM 4XXX n ₁ n ₂ n ₃ n ₄			
Options	n ₁	n ₂	n ₃
Mounting	o		
Function		o	
Delivery package information			o

Options	Description
n ₁	S Surface mount
n ₂	D Standard config PMBus
n ₃	/B Tray /C Tape and Reel

Example a 200W, surface mounted, standard configuration with tray packaging would be PIM 4206SD/B.

* Standard variant (i.e. no option selected).

General Information

Reliability

The failure rate (λ) and mean time between failures (MTBF = $1/\lambda$) is calculated at max output power and an operating ambient temperature (T_A) of +40°C. Flex Power Modules uses Telcordia SR-332 Issue 2 Method 1 to calculate the mean steady-state failure rate and standard deviation (σ).

Telcordia SR-332 Issue 2 also provides techniques to estimate the upper confidence levels of failure rates based on the mean and standard deviation.

Mean steady-state failure rate, λ	Std. deviation, σ
447 nFailures/h	53 nFailures/h

MTBF (mean value) for the PIM series = 2.24 Mh.
MTBF at 90% confidence level = 1.94 Mh

The products are compatible with the relevant clauses and requirements of the RoHS directive 2011/65/EU and have a maximum concentration value of 0.1% by weight in homogeneous materials for lead, mercury, hexavalent chromium, PBB and PBDE and of 0.01% by weight in homogeneous materials for cadmium.

Exemptions in the RoHS directive utilized in Flex Power Modules products are found in the Statement of Compliance document.

Flex Power Modules fulfills and will continuously fulfill all its obligations under regulation (EC) No 1907/2006 concerning the registration, evaluation, authorization and restriction of chemicals (REACH) as they enter into force and is through product materials declarations preparing for the obligations to communicate information on substances in the products.

Quality Statement

The products are designed and manufactured in an industrial environment where quality systems and methods like ISO 9000, Six Sigma, and SPC are intensively in use to boost the continuous improvements strategy. Infant mortality or early failures in the products are screened out and they are subjected to an ATE-based final test. Conservative design rules, design reviews and product qualifications, plus the high competence of an engaged work force, contribute to the high quality of the products.

Warranty

Warranty period and conditions are defined in Flex Power Modules General Terms and Conditions of Sale.

Limitation of Liability

Flex Power Modules does not make any other warranties, expressed or implied including any warranty of merchantability or fitness for a particular purpose (including, but not limited to, use in life support applications, where malfunctions of product can cause injury to a person's health or life).

© Flex 2017

The information and specifications in this technical specification is believed to be correct at the time of publication. However, no liability is accepted for inaccuracies, printing errors or for any consequences thereof. Flex reserves the right to change the contents of this technical specification at any time without prior notice.

Compatibility with RoHS requirements

PIM 4006 SD series Power Interface Module Input 36-60 V, Output up to 10.3 A / 100-400 W	28701-BMR45530 Rev D November 2017
	© Flex

Safety Specification

General information

Flex Power Modules DC/DC converters and DC/DC regulators are designed in accordance with the safety standards IEC 60950-1, EN 60950-1 and UL 60950-1 *Safety of Information Technology Equipment*.

IEC/EN/UL 60950-1 contains requirements to prevent injury or damage due to the following hazards:

- Electrical shock
- Energy hazards
- Fire
- Mechanical and heat hazards
- Radiation hazards
- Chemical hazards

On-board DC/DC converters, Power interface modules and DC/DC regulators are defined as component power supplies. As components they cannot fully comply with the provisions of any safety requirements without "conditions of acceptability". Clearance between conductors and between conductive parts of the component power supply and conductors on the board in the final product must meet the applicable safety requirements. Certain conditions of acceptability apply for component power supplies with limited stand-off (see Mechanical Information and Safety Certificate for further information). It is the responsibility of the installer to ensure that the final product housing these components complies with the requirements of all applicable safety standards and regulations for the final product.

Component power supplies for general use should comply with the requirements in IEC/EN/UL 60950/1 *Safety of Information Technology Equipment*. Product related standards, e.g. IEEE 802.3af *Power over Ethernet*, and ETS-300132-2 *Power interface at the input to telecom equipment, operated by direct current (dc)* are based on IEC/EN/UL 60950-1 with regards to safety.

Flex Power Modules DC/DC converters, Power interface modules and DC/DC regulators are UL 60950-1 recognized and certified in accordance with EN 60950-1. The flammability rating for all construction parts of the products meet requirements for V-0 class material according to IEC 60695-11-10, *Fire hazard testing, test flames – 50 W* horizontal and vertical flame test methods.

Power interface modules

The product may provide basic or functional insulation between input and output according to IEC/EN/UL 60950-1 (see Safety Certificate), different conditions shall be met if the output of a basic or a functional insulated product shall be considered as safety extra low voltage (SELV).

For basic insulated products (see Safety Certificate) the output is considered as safety extra low voltage (SELV) if one of the following conditions is met:

- The input source provides supplementary or double or reinforced insulation from the AC mains according to IEC/EN/UL 60950-1.
- The input source provides functional or basic insulation from the AC mains and the product's output is reliably connected to protective earth according to IEC/EN/UL 60950-1.

For functional insulated products (see Safety Certificate) the output is considered as safety extra low voltage (SELV) if one of the following conditions is met:

- The input source provides double or reinforced insulation from the AC mains according to IEC/EN/UL 60950-1.
- The input source provides basic or supplementary insulation from the AC mains and the product's output is reliably connected to protective earth according to IEC/EN/UL 60950-1.
- The input source is reliably connected to protective earth and provides basic or supplementary insulation according to IEC/EN/UL 60950-1 and the maximum input source voltage is 60 Vdc.

Galvanic isolation between input and output is verified in an electric strength test and the isolation voltage (V_{iso}) meets the voltage strength requirement for basic insulation according to IEC/EN/UL 60950-1.

It is recommended to use a slow blow fuse at the input of each product. If an input filter is used in the circuit the fuse should be placed in front of the input filter. In the rare event of a component problem that imposes a short circuit on the input source, this fuse will provide the following functions:

- Isolate the fault from the input power source so as not to affect the operation of other parts of the system
- Protect the distribution wiring from excessive current and power loss thus preventing hazardous overheating

Non-isolated DC/DC regulators

The DC/DC regulator output is SELV if the input source meets the requirements for SELV circuits according to IEC/EN/UL 60950-1.

PIM 4006 SD series Power Interface Module
 Input 36-60 V, Output up to 10.3 A / 100-400 W

28701-BMR45530 Rev D November 2017
 © Flex

Absolute Maximum Ratings

Characteristics		min	typ	max	Unit
T _{PI}	Operating Temperature (see Thermal Consideration section)	-40		+105	°C
T _S	Storage temperature	-55		+125	°C
V _I	Input voltage	-60		70	V
V _I	Input voltage, reverse polarity			60	V
V _I	Input voltage transient ANSI T1.315-2001 (R2006)			100	V
V _I	Common mode surge pulses (1.2/50 μs) IEC 61000-4-5			500	V
V _{IN2}	PMBus input voltage	-0.3		4.1	V
V _{SA0} , V _{SA1}	PMBus address pin-strap	-0.3		V _{IN2} + 0.3	V
V _{PG}	Power good, open collector voltage			120	V
I _{PG}	Power good, sink current			100	mA
V _{SCL}	PMBus clock	-0.3		V _{IN2} + 0.3	V
V _{SDA}	PMBus data	-0.3		V _{IN2} + 0.3	V
V _{SALERT}	PMBus alert	-0.3		V _{IN2} + 0.3	V

Stress in excess of Absolute Maximum Ratings may cause permanent damage. Absolute Maximum Ratings, sometimes referred to as no destruction limits, are normally tested with one parameter at a time exceeding the limits in the Electrical Specification. If exposed to stress above these limits, function and performance may degrade in an unspecified manner.

Fundamental Circuit Diagram

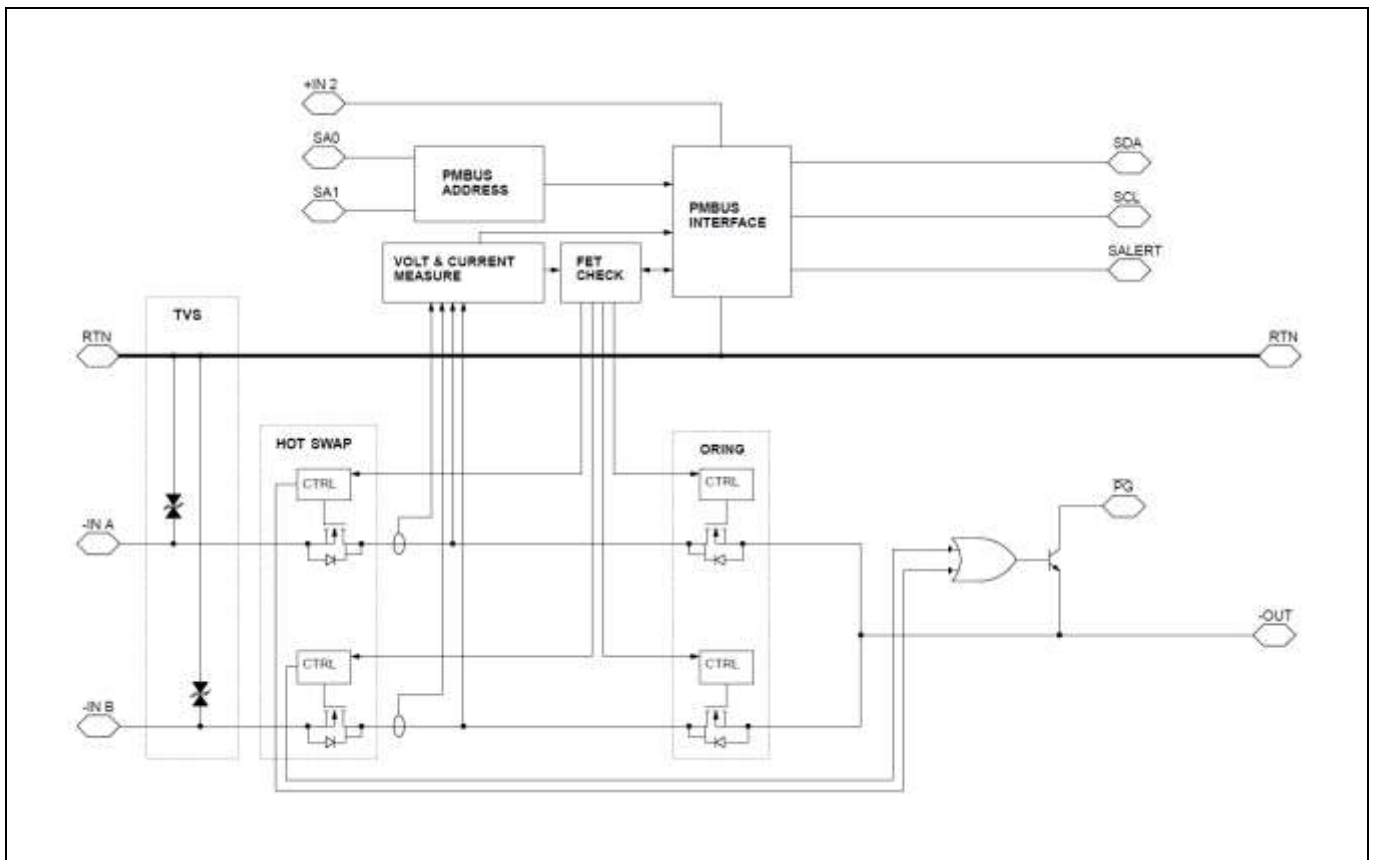

Technical Specification

PIM 4006 SD series Power Interface Module
Input 36-60 V, Output up to 10.3 A / 100-400 W

28701-BMR45530 Rev D November 2017

© Flex

Functional Description

Minimum and maximum values given at $T_{P1} = -30$ to 90 °C, $V_I = 36$ to 60 V and typical values given at: $T_{P1} = +25$ °C, $V_I = 53$ V.

Characteristics		Comments	min	typ	max	Unit
PMBus monitoring accuracy						
READ_VINA READ_VINB READ_VIN	Input A voltage Input B voltage ORed input voltage		-1	±0.25	1	%
READ_IINA READ_IINB READ_IOUT	Input A current Input B current Output current		-3		3	% of max I_O
READ_PIN	Input power			±3		% of max P_O
READ_TEMPERATURE_1	P1 temperature	$T_{P1} = 25$ to 90 °C	-5	±3	5	°C
Fault Protection Characteristics						
UVLO, input under voltage lockout	Delay			1		ms
OCP, over current protection	Fault response time			1.5		ms
OTP, over temperature protection	Trip limit			120		°C
	Hysteresis			10		°C

Command			Read	Format
Registers				
MFR_FETCHECK	FET check launch register	Read/Write byte	Initial state: 00h	bit field
MFR_FETCHECKSTATUS	Status register	Read word	Initial state: 00h	bit field
Status command				
STATUS_BYTE	Only CML bit used (communication fault only)	Read word PMBus spec. 1.2 17.1	Initial state: 00h	bit field
PMBus revision				
PMBUS_REVISION	PMBus revision	Read byte PMBus spec. 1.2 22.1	Example: 1.2	bit field

Characteristics		Conditions	Read	Unit
Manufacturer's information				
MFR_ID	Manufacturer's ID	Read block, format: 8 byte	ERICSSON	ASCII
MFR_MODEL	Manufacturer's type designation	Read block, format: 12 byte	Example: PIM4306SD	ASCII
MFR_REVISION	Product's revision	Read block, format: 3 byte	Example: R1A	ASCII
MFR_DATE	Date of manufacture	Read block, format: YYMMDD	Example: 130425	ASCII

Characteristics			min	typ	max	Unit
Logic Input/Output						
PMBus frequency			10		400	kHz
Negative-going input threshold voltage (V_{IT-})	SCL, SDA		$0.25 \times V_{IN2}$		$0.55 \times V_{IN2}$	V
Positive-going input threshold voltage (V_{IT+})			$0.45 \times V_{IN2}$		$0.75 \times V_{IN2}$	
Logic output low (V_{OL})	SCL, SDA, SALERT	$I_{OL} = 1.5$ mA			0.25	
		$I_{OL} = 6$ mA			0.6	
Logic output low (V_{OL})	PG (sink current 2 mA)				1	
Bus free time (T_{BUF})	Note 1	After read access	1.3			µs
		After write access	30			

Note 1: It is recommended that a PMBus master reads back written data for verification i.e. do not rely on the ACK/NACK bit since this bit are as susceptible to errors as any other bit. However, under very rare operating conditions, it is possible to get intermittent read back failures. It is therefore recommended to implement error handling in the master that also deals with those situations.

Technical Specification

PIM 4006 SD series Power Interface Module
Input 36-60 V, Output up to 10.3 A / 100-400 W

28701-BMR45530 Rev D November 2017

© Flex

Electrical Specification

Minimum and maximum values given at $T_{P1} = -30$ to 90 °C, $V_I = 36$ to 60 V and typical values given at: $T_{P1} = +25$ °C, $V_I = 53$ V.

Characteristics		Conditions	min	typ	max	Unit
V_I	Input voltage range		36	53	60	V
$V_{I\ off}$	Turn-off threshold voltage, decreasing feed A and B voltage		32	33		V
$V_{I\ on}$	Turn-on threshold voltage, Increasing feed A or B voltage			35	36	
V_{OVP}	OVP turn-off threshold voltage, Increasing feed A or B voltage			83		
C_I	Internal input capacitance			0.1		μF
P_{li}	Input idling power	$V_I = 53$ V, $I_O = 0$ A		0.6		W
I_{UVLO}	Input standby current	$V_I <$ turn off input voltage.			10	mA
V_{IN2}	PMBus input voltage range		3.0	3.3	3.6	V
I_{IN2}	PMBus input current				20	mA

Characteristics		Conditions	PIM 4106 SD	PIM 4206 SD	PIM 4306 SD	PIM 4406 SD	Unit
η	Efficiency	max P_O	typ 99.3	typ 99.5	typ 99.5	typ 99.5	%
P_d	Power dissipation	max I_O	max 1.2	max 1.9	max 3.2	max 5.7	W
		$V_I = 53$ V, max P_O	typ 0.7	typ 1.0	typ 1.3	typ 2.1	
P_O	Output power	$V_I = 39$ V, see Note 2	max 100	max 200	max 300	max 400	W
I_O	Output current	see Note 3	max 2.6	max 5.2	max 7.7	max 10.3	A
I_{lim}	Output current limit threshold (OCP)	$T_{P1} <$ max T_{P1}	max 4.7	max 9.4	max 14.0	max 16.8	A
			typ 4.2	typ 8.3	typ 12.5	typ 15.0	
			min 3.6	min 7.3	min 11.0	min 13.2	
I_{sc}	Short circuit current	$T_{P1} = 25$ °C, see Note 5	max 0.4	max 0.8	max 1.2	max 1.4	A
I_{PK}	Inrush current transient	≤ 0.1 ms after application of input power	max 0.01	max 0.01	max 0.01	max 0.01	A
		> 0.1 ms after application of input power (max-value)	$1.3 \times$ max I_{lim}	$1.3 \times$ max I_{lim}	$1.3 \times$ max I_{lim}	$1.3 \times$ max I_{lim}	
t_s	Start-up time (from V_I connection to PG)	$V_I = 53$ V, $I_O = 0$ A, max C_O , see Note 4	typ 300	typ 300	typ 300	typ 300	ms
		$V_I = 53$ V, $I_O = 0$ A, min C_O , see Note 4	typ 180	typ 22	typ 22	typ 22	
t_r	Ramp-up time (from 10 to 90% of V_O)	$V_I = 53$ V, $I_O = 0$ A, max C_O , see Note 3	typ 300	typ 300	typ 300	typ 300	ms
		$V_I = 53$ V, $I_O = 0$ A, min C_O , see Note 3	typ 150	typ 0.6	typ 0.6	typ 0.6	
C_O	Recommended Capacitive Load	$T_{P1} = 25$ °C	max 250	max 500	max 750	max 600	μF
			min 100	min 100	min 150	min 200	

Note 2: the maximum output power increases with increased input voltage (maximum output current shall not be exceeded)

Note 3: no load before power good, see "Operating Information" section entitled "Start-up procedure"

Note 4: the start-up time increases with increased output capacitance, see Typical Characteristics section, Start-up with maximum output capacitance

Note 5: rms current, hiccup at short circuit

PIM 4006 SD series Power Interface Module
 Input 36-60 V, Output up to 10.3 A / 100-400 W

28701-BMR45530 Rev D November 2017

© Flex

Typical Characteristics

Efficiency

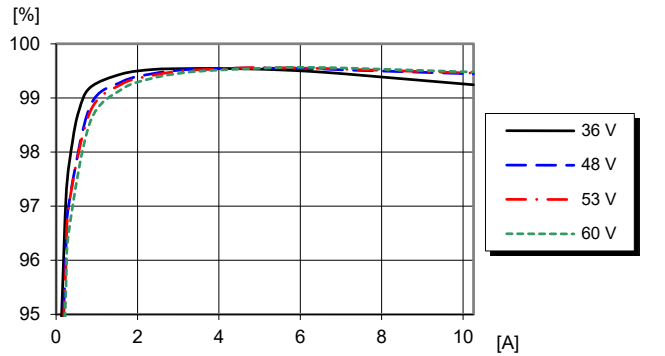

Efficiency vs. load current and input voltage at $T_{P1} = +25\text{ }^{\circ}\text{C}$

Note: max 10.3 A output current for PIM 4406 SD
 max 7.7 A output current for PIM 4306 SD
 max 5.2 A output current for PIM 4206 SD
 max 2.6 A output current for PIM 4106 SD

Power Dissipation

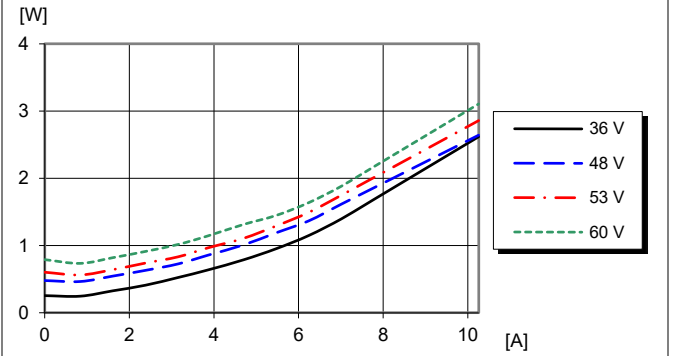

Dissipated power vs. load current and input voltage at $T_{P1} = +25\text{ }^{\circ}\text{C}$

Note: max 10.3 A output current for PIM 4406 SD
 max 7.7 A output current for PIM 4306 SD
 max 5.2 A output current for PIM 4206 SD
 max 2.6 A output current for PIM 4106 SD

Output Current Derating

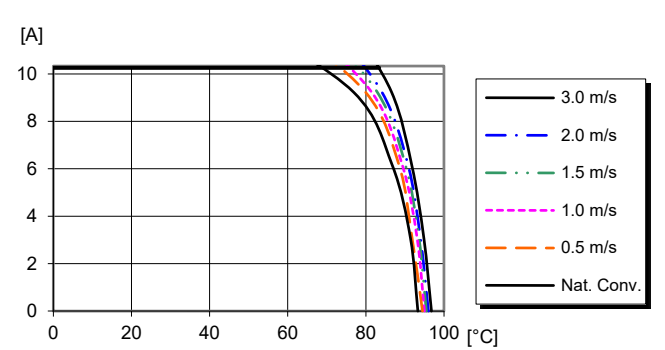

Available load current vs. ambient air temperature and airflow at $V_1 = 53\text{ V}$.

Note: max 10.3 A output current for PIM 4406 SD
 max 7.7 A output current for PIM 4306 SD
 max 5.2 A output current for PIM 4206 SD
 max 2.6 A output current for PIM 4106 SD

PIM 4006 SD series Power Interface Module
 Input 36-60 V, Output up to 10.3 A / 100-400 W

28701-BMR45530 Rev D November 2017

© Flex

Typical Characteristics

Start-up with minimum output capacitance

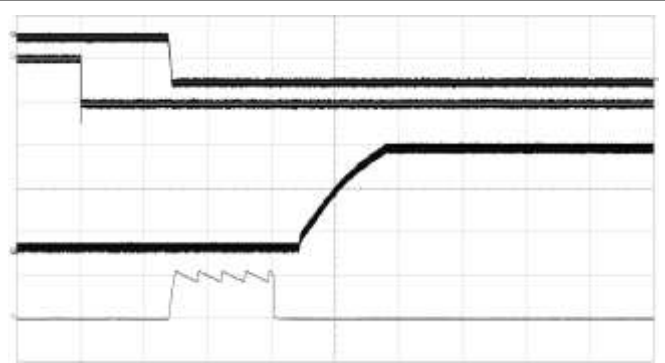

PIM 4306 SD start-up of a DC/DC converter, PKB 4113C, using its RC function at:
 $T_{P1} = +25\text{ }^{\circ}\text{C}$, output capacitance = 100 μF , PG activates the converter's RC function, see Start-up Procedure section.

Top trace: output voltage (50 V/div.)
 Second trace: input voltage (50 V/div.)
 Third trace: DC/DC output voltage (5 V/div.)
 Bottom trace: PG-signal (5 V/div.) (the sawtooth voltage originates from the DC/DC)
 Time scale: (10 ms/div.)

Start-up with maximum output capacitance

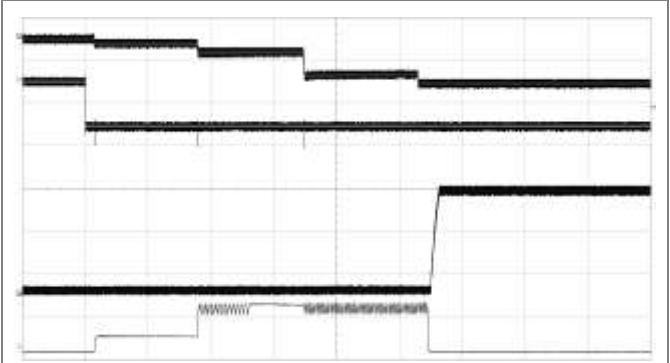

PIM 4306 SD start-up of a DC/DC converter, PKB 4113C, using its RC function at:
 $T_{P1} = +25\text{ }^{\circ}\text{C}$, output capacitance = 750 μF , PG activates the converter's RC function, see Start-up Procedure section.

Top trace: output voltage (50 V/div.)
 Second trace: input voltage (50 V/div.)
 Third trace: DC/DC output voltage (5 V/div.)
 Bottom trace: PG-signal (5 V/div.) (the sawtooth voltage originates from the DC/DC)
 Time scale: (100 ms/div.)

ORing – feed switch

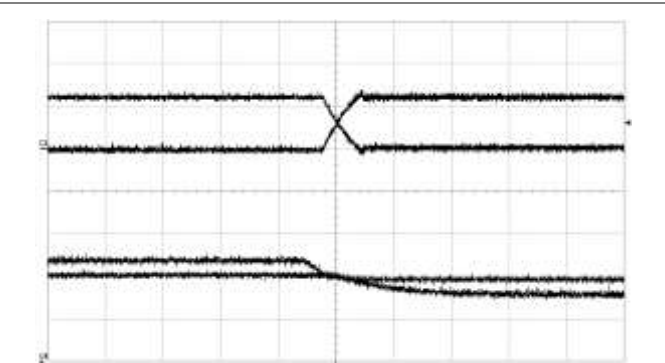

ORing at:
 $T_{P1} = +25\text{ }^{\circ}\text{C}$, $V_{IA} = 54\text{-}52\text{ V}$, $V_{IB} = 53\text{ V}$, $I_o = 8.33\text{ A}$ electronic load

Top trace: input A current (5 A/div.)
 Second trace: input B current (5 A/div.)
 Third trace: input A voltage (2 V/div.)
 Bottom trace: input B voltage (2 V/div.)
 Time scale: (0.1 s/div.)

ORing – short circuit of the feed with highest voltage

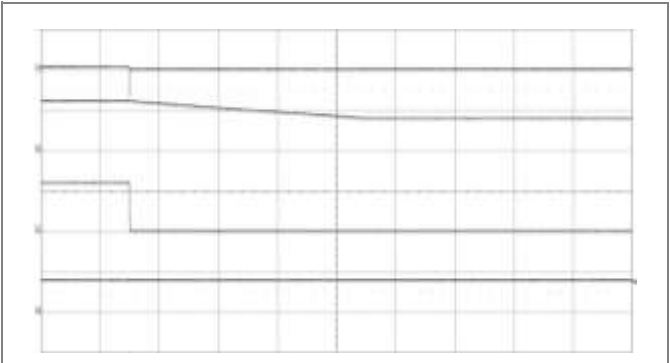

ORing functionality at:
 $T_{P1} = +25\text{ }^{\circ}\text{C}$, $V_{IA} = 60\text{ V}$ (before short circuit), $V_{IB} = 40\text{ V}$, output load = 10 k Ω

Top trace: input A current (1 A/div.)
 Second trace: output voltage (50 V/div.)
 Third trace: input A voltage (50 V/div.)
 Bottom trace: input B voltage (50 V/div.)
 Time scale: (10 ms/div.)

FET check

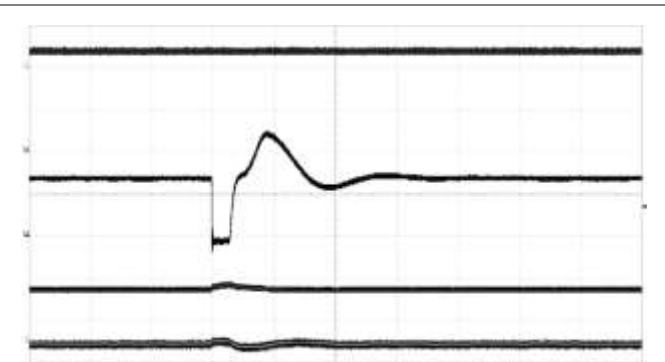

FET check at:
 $T_{P1} = +25\text{ }^{\circ}\text{C}$, $V_{IA} = 53\text{ V}$, $V_{IB} = 48\text{ V}$, output capacitance = 100 μF , output loaded with a DC/DC converter, PKB 4113C, $I_{DC/DC} = 12\text{ A}$
 See FET check section

Top trace: DC/DC output voltage (5 V/div.)
 Second trace: input current (2 A/div.)
 Third trace: output voltage (10 V/div.)
 Bottom trace: PG-signal (10 V/div.)
 Time scale: (0.1 ms/div.)

PIM 4006 SD series Power Interface Module
 Input 36-60 V, Output up to 10.3 A / 100-400 W

28701-BMR45530 Rev D November 2017

© Flex

Typical Application Circuit

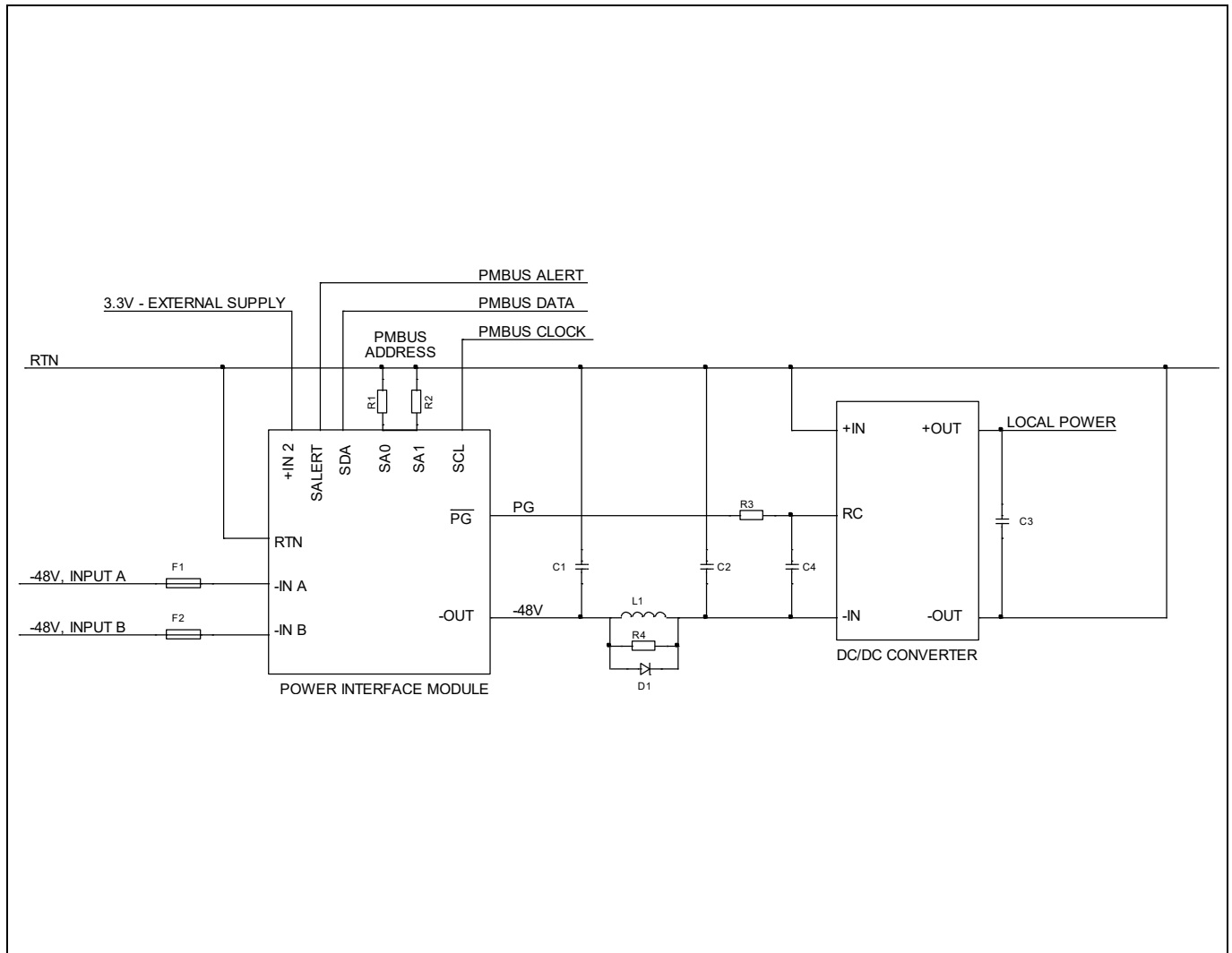

External components

- C1 = Filter capacitor
- C2 = DC/DC converter input capacitor (see technical specification for the DC/DC converter)
- C3 = DC/DC converter output capacitor (see technical specification for the DC/DC converter)
- C4 = PG filter capacitor (see Power Good and filter inductor section)
- D1 = Inductor ringing clamp diode
- F1 = fuse
- F2 = fuse
- L1 = Filter inductor
- R1 = PMBus address pin-strap resistor, R_{SA0} (see PMBus Addressing section)
- R2 = PMBus address pin-strap resistor, R_{SA1} (see PMBus Addressing section)
- R3 = PG filter resistor (see Power Good and filter inductor section)
- R4 = Inductor ringing damping resistor

PIM 4006 SD series Power Interface Module
 Input 36-60 V, Output up to 10.3 A / 100-400 W

28701-BMR45530 Rev D November 2017
 © Flex

EMC Recommendations

Recommendations for external components to meet the requirements according to EN55022, CISPR 22 and FCC part 15J class B (see test set up), when the PIM is used in conjunction with Flex BMR 456 0004 and BMR 457 0004 DC/DC converters.

Conducted EMI Input terminal peak value (typ)

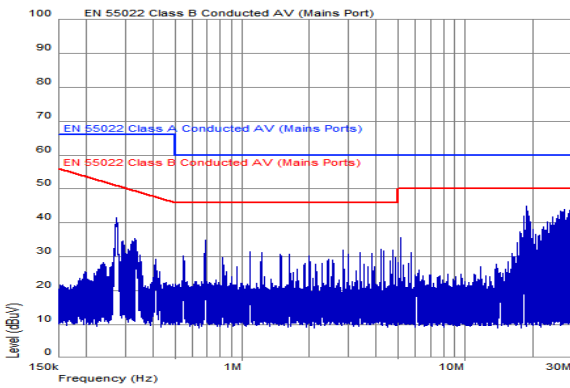

in combination with BMR 456 0004

$V_I = 53\text{ V}$, $P_O = 400\text{ W}$, $I_{BMR4560004} = 33\text{ A}$
 $C1 = 220\text{ }\mu\text{F}$, $C2 = 220\text{ }\mu\text{F}$, $C3 = 1500\text{ }\mu\text{F}$, $C4 = 100\text{ nF}$,
 $L1 = 22\text{ }\mu\text{H}$, $R3 = 1\text{ k}\Omega$, $R4 = \text{not populated}$

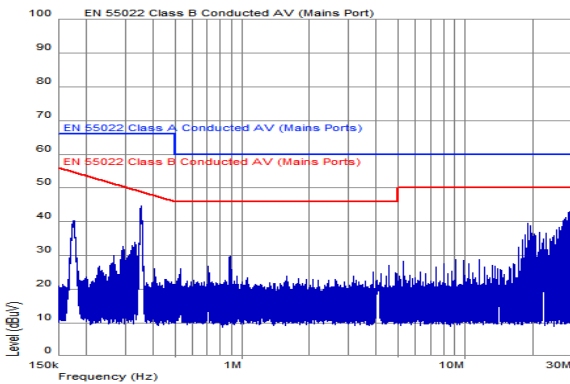

in combination with BMR 457 0004

$V_I = 53\text{ V}$, $P_O = 265\text{ W}$, $I_{BMR4570004} = 21\text{ A}$
 $C1 = 220\text{ }\mu\text{F}$, $C2 = 330\text{ }\mu\text{F}$, $C3 = 1500\text{ }\mu\text{F}$, $C4 = 100\text{ nF}$,
 $L1 = 22\text{ }\mu\text{H}$, $R3 = 1\text{ k}\Omega$, $R4 = \text{not populated}$

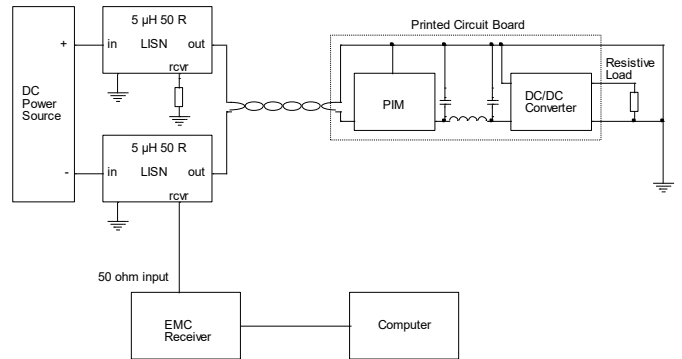

Test set-up

Power Good and filter inductor

When the PIM is used with a filter inductor, L1 in Typical Application Circuit diagram, special considerations must be made regarding the connection between the PG-output of the PIM and the RC-input of the DC/DC converter. During some modes of operation (e.g. input voltage transients) voltage ringing may appear across the filter inductor. This ringing may be substantial enough to cause either the DC/DC converter to momentarily turn off or cause excessive negative voltage on the RC-input if the PG-output is directly connected to the RC-input.

A filter on the PG-signal (R3 and C4) can be used to remedy this problem. The resistance of R3 must be low enough to keep the voltage level on the RC-input below its turn-on threshold. A 1 kΩ resistor works well with BMR 456, BMR 457 and PKB-C. Clamping diodes across the filter inductor may also be used. The diode D1 in the Application Circuit diagram will prevent -OUT of the PIM from going more than a diode drop higher than -IN of the DC/DC converter. This will prevent the voltage on the RC-pin from going above the turn off threshold. The voltage on the RC-pin could still be negative if -OUT of the PIM goes below -IN of the DC/DC converter. Another diode, anti-parallel to D1, would solve this problem.

PIM 4006 SD series Power Interface Module Input 36-60 V, Output up to 10.3 A / 100-400 W	28701-BMR45530 Rev D November 2017
	© Flex

Operating information

Power Management Overview

This product is equipped with a PMBus interface. The product incorporates a range of readable and configurable power management features that are simple to implement with a minimum of external components. Additionally, the product includes protection features that continuously safeguard the load from damage due to unexpected system faults. The following product parameters can continuously be monitored by a host: input A voltage, input B voltage, ORed input voltage, input A current, input B current, output current, and internal junction temperature.

Input Voltage

The input voltage range 36 to 60 Vdc meets the requirements of the European Telecom Standard ETS 300 132-2 for normal input voltage range in -48 systems, -40.5 to -57.0 V.

A/B Feed ORing

Two MOSFETs (one ORing control) provide ORing of the input feeds. If a short is detected on one of the feeds the control circuit will detect reverse current and quickly turn the MOSFETs off. This feature also protects the product against reverse polarity up to 60 V. If a fuse blow is desired in case of wrong polarity place TVS diodes between negative and positive branch in both feeds. At high load operation the MOSFETs are operated at a low $RDS_{(on)}$ condition.

ORing and hot swap MOSFET short circuit check

A short circuited ORing or hot swap MOSFET can be detected by using the MFR_FETCHECK-command via the PMBus interface.

Hot Swap Functionality

The hot swap function is designed to control the inrush current to the downstream DC/DC converter. The level and duration of the inrush current complies with inrush current limits for PICMG 3.0 ATCA boards.

Note: The hot swap circuit limits the output current during start up. Hence, the output cannot be loaded before its external filter capacitor has been charged (power good pin (PG) is asserted)

Start-up Procedure

The product follows a specific internal start-up procedure after power is applied to input A or input B:

1. When input A or input B reaches the turn on voltage level, the charging of the external filter capacitor starts.
2. When the output voltage is equal to the input voltage the power good pin (PG) is asserted.
3. The downstream DC/DC converter turns on when PG activates the converter's RC function.
4. The DC/DC converter powers a step-down converter as supplies input 2.
5. After power is applied to input 2 the PMBus address (according to the pin-strap) is loaded.

Once this procedure is completed the product is ready to be loaded and accept commands via the PMBus interface, which will overwrite any default values used during the start-up procedure.

Power Good

The power good (PG) pin indicates that the output is ready to be loaded. An open collector turns on (sinks current) when the output voltage is equal to the voltage present on input A or input B. PG is referenced to -OUT.

PMBus, external power supply

The PMBus interface requires an external 3.3V power supply (+IN 2). ORing and hot swap will work without the external power supply but the PMBus communication will not.

Technical Specification

PIM 4006 SD series Power Interface Module Input 36-60 V, Output up to 10.3 A / 100-400 W	28701-BMR45530 Rev D November 2017
	© Flex

Input Transient Over Voltage Protection

The product incorporates a transient voltage protector which will protect the product and the downstream DC/DC converter against over voltage transients exceeding 70 V. The transient voltage protector is rated for 1.5 kW peak pulse power with a breakdown voltage of 71 V. The product also handles transients of up to 100 V for 10 μ s.

Over Voltage Protection (OVP)

The product includes over voltage limiting circuitry for protection of the load from continuous high voltage. When the input voltage exceeds 75 V the product will shut down. The product will resume normal operation automatically when the input voltage is within its specified range.

Over Temperature Protection (OTP)

The product includes over temperature limiting circuitry for protection of the load. When T_{P1} as defined in thermal consideration section exceeds 120 °C the product will shut down. The product will make continuous attempts to start up (non-latching mode) and resume normal operation automatically when the temperature has dropped > 10 °C below the temperature threshold.

Over Current Protection (OCP)

The product includes current limiting circuitry for protection at continuous overload.

The output will abruptly be interrupted if the output overcurrent- or an internal component overpower thresholds are exceeded for a time longer than the stated fault response time.

Technical Specification

PIM 4006 SD series Power Interface Module
 Input 36-60 V, Output up to 10.3 A / 100-400 W

28701-BMR45530 Rev D November 2017
 © Flex

Thermal Consideration

General

The products are designed to operate in different thermal environments and sufficient cooling must be provided to ensure reliable operation.

For products mounted on a PCB without a heat sink attached, cooling is achieved mainly by conduction, from the pins to the host board, and convection, which is dependent on the airflow across the product. Increased airflow enhances the cooling of the product. The Output Current Derating graphs found in the Output section provides the available output current vs. ambient air temperature and air velocity at $V_I = 53\text{ V}$

A guard band of 5 °C is applied to the maximum recorded component temperatures when calculating output current derating curves.

The product is tested on a 254 x 254 mm, 35 µm (1 oz.), 16-layer test board mounted vertically in a wind tunnel with a cross-section of 608 x 203 mm.

Definition of product operating temperature

The product operating temperature is used to monitor the temperature of the product, and proper thermal conditions can be verified by reading the temperature via PMBus. The temperature shall not exceed the maximum temperature in the table below. Temperatures above maximum T_{P1} , is not allowed and may cause permanent damage.

Description	Max Temp.
PMBus temperature	$T_{P1} = 105\text{ °C}$

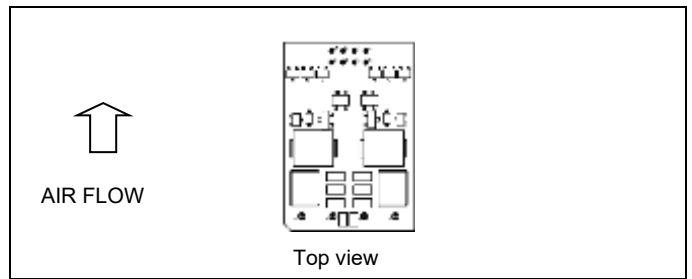

Temperature position and air flow direction.

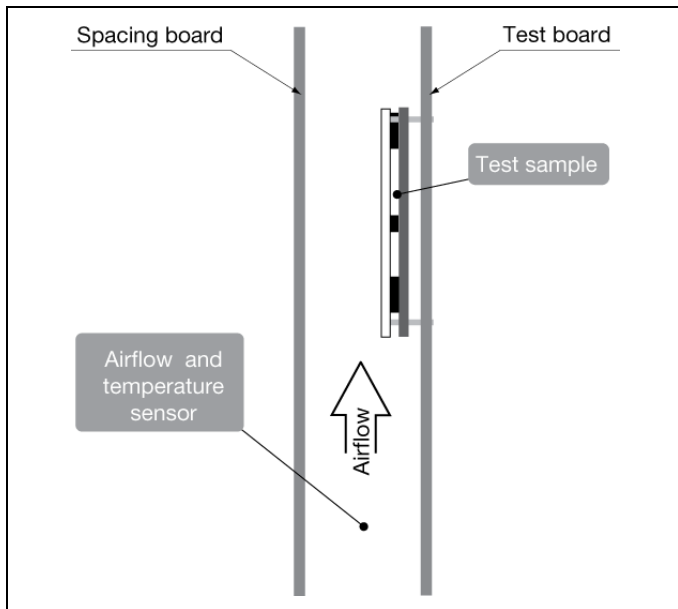

Technical Specification

PIM 4006 SD series Power Interface Module
 Input 36-60 V, Output up to 10.3 A / 100-400 W

28701-BMR45530 Rev D November 2017

© Flex

Connections

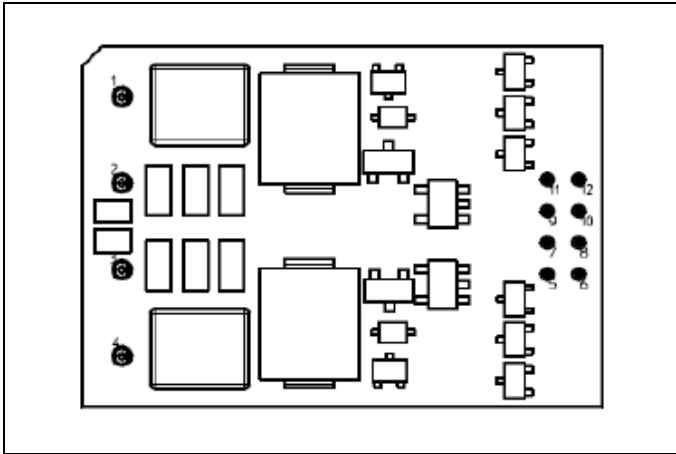

Pin layout, top view (component placement for illustration only).

Pin	Designation	Function
1	RTN	Return
2	-IN A	Input A, negative feed
3	-IN B	Input B, negative feed
4	-OUT	Negative output
5	NC	Not connected
6	PG	Power Good
7	SCL	PMBus clock
8	SA1	PMBus address pin-strap 1
9	SA0	PMBus address pin-strap 0
10	SDA	PMBus data
11	SALERT	PMBus alert
12	+IN 2	Management power supply (referred to RTN/GND)

Technical Specification

PIM 4006 SD series Power Interface Module
Input 36-60 V, Output up to 10.3 A / 100-400 W

28701-BMR45530 Rev D November 2017

© Flex

PMBus Interface

This product provides a PMBus digital interface that enables the user to monitor the input voltages, input currents and device temperature. The product can be used with any standard two-wire I²C or SMBus host device. In addition, the module is compatible with PMBus version 1.2. The product supports bus clock frequencies from 10 to 400 kHz. External pull-up resistors may be added to the PMBus.

Monitoring via PMBus

It is possible to monitor a variety of different parameters and status/fault flags through the PMBus interface. It is also possible to continuously monitor one or more of the below parameters:

Monitored parameters

- Feed A voltage
- Feed B voltage
- ORed input voltage
- Feed A current
- Feed B current
- Output current
- Internal junction temperature

Monitored status/fault flags

- FET check feed A fail
- FET check feed B fail

PMBus Addressing

The PMBus address should be configured with resistors connected between the SA0/SA1 pins and the RTN pin, as shown in the figure below. Recommended resistor values for hard-wiring PMBus addresses are shown in the table. 1% tolerance resistors are required.

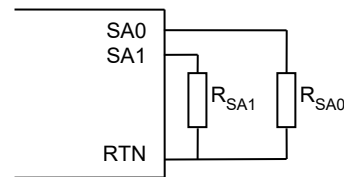

Schematic of connection of address resistor.

SA0 index	R _{SA0}	SA1 index	R _{SA1}
7	open	7	open
6	100 kΩ	6	100 kΩ
5	47 kΩ	5	47 kΩ
4	27 kΩ	4	27 kΩ
3	18 kΩ	3	18 kΩ
2	10 kΩ	2	10 kΩ
1	4.7 kΩ	1	4.7 kΩ
0	closed	0	closed

The PMBus address follows the equation below:

Eq. 8

$$\text{PMBus address (decimal)} = 8 \times (\text{SA1 index}) + (\text{SA0 index})$$

Note: PMBus address = 127d for closed R_{SA0} and R_{SA1}

The user can theoretically configure up to 64 unique PMBus addresses. The user shall also be aware of further limitations of the address space as stated in the SMBus Specification.

Technical Specification

PIM 4006 SD series Power Interface Module
Input 36-60 V, Output up to 10.3 A / 100-400 W

28701-BMR45530 Rev D November 2017

© Flex

PMBus Commands

The product is PMBus compliant. The following table lists the implemented PMBus commands. For more detailed information see PMBus Power System Management Protocol Specification; Part I – General Requirements, Transport and Electrical Interface and PMBus Power System Management Protocol; Part II – Command Language.

Designation	Cmd	Impl
PMBUS_OPERATION	01h	Yes
CLEAR_FAULTS	03h	Yes
STATUS_BYTE	78h	Yes
READ_VIN (LINEAR)	88h	Yes
READ_IOUT (LINEAR)	8Ch	Yes
READ_TEMPERATURE_1 (LINEAR)	8Dh	Yes
PMBUS_REVISION	98h	Yes
MFR_ID	99h	Yes
MFR_MODEL	9Ah	Yes
MFR_REVISION	9Bh	Yes
MFR_LOCATION	9Ch	Yes
MFR_DATE	9Dh	Yes
MFR_SERIAL	9Eh	Yes
MFR_READ_VINA (LINEAR)	D3h	Yes
MFR_READ_VINB (LINEAR)	D4h	Yes
MFR_READ_IINA (LINEAR)	D6h	Yes
MFR_READ_IINB (LINEAR)	D7h	Yes
MFR_FETCHCHECK	D8h	Yes
MFR_FETCHCHECKSTATUS	D9h	Yes

Notes:

Cmd is short for Command.

Impl is short for Implemented.

RW is short for Read Write access

CLEAR_FAULTS only supports clearing of the CML bit.

STATUS_BYTE only supports reading of the CML bit.

LINEAR, value is represented in PMBus LINEAR format.

MFR_FETCHCHECK

A read/write register to start a FET check operation. Write 55h followed by AAh to launch FET check on feed A. Write 56h followed by ABh to launch FET check on feed B.

Designation	Bit
COMMAND KEY	0-7

MFR_FETCHCHECKSTATUS

A read only register that displays current status.

Designation	Bit
FEED_A_TESTING	0
FEED_B_TESTING	1
FEED_A_RECOVER	2
FEED_B_RECOVER	3
FEED_A_UV	4
FEED_B_UV	5
FEED_A_TEST_PASS	6
FEED_B_TEST_PASS	7
CMD_IGNORED	8
FEED_A_LOSS	9
FEED_B_LOSS	10
FEED_A_VALID	11
FEED_B_VALID	12
Reserved	13-15

MFR_FETCHCHECKSTATUS flag description

Designation	Function
FEED_A_TESTING	Asserted when a FET check is in progress on feed A. When asserted a new test cannot be started.
FEED_B_TESTING	Asserted when a FET check is in progress on feed B. When asserted a new test cannot be started.
FEED_A_RECOVER	Asserted for 1 s when a FET check on feed A has finished. When asserted a new test cannot be started.
FEED_B_RECOVER	Asserted for 1 s when a FET check on feed B has finished. When asserted a new test cannot be started.
FEED_A_UV	Asserted when the input voltage

PIM 4006 SD series Power Interface Module
 Input 36-60 V, Output up to 10.3 A / 100-400 W

28701-BMR45530 Rev D November 2017
 © Flex

	on feed A goes below 45 V, de-asserted above 46 V. When asserted a new test cannot be started.
FEED_B_UV	Asserted when the input voltage on feed B goes below 45 V, de-asserted above 46 V. When asserted a new test cannot be started.
FEED_A_TEST_PASS	Test result 1 = Test passed 0 = Test failed Valid when FEED_A_TESTING has de-asserted.
FEED_B_TEST_PASS	Test result 1 = Test passed 0 = Test failed Valid when FEED_B_TESTING has de-asserted.
CMD_IGNORED	Asserted when a FET check start command is given and any of bits 0 through 5 of MFR_FETCHECKSTATUS is asserted. The command is ignored. De-asserted when a FET check is successfully launched.
FEED_A_LOSS	1 = $V_{INA} < 36.9V$ 0 = $V_{INA} > 38.4V$
FEED_B_LOSS	1 = $V_{INB} < 36.9V$ 0 = $V_{INB} > 38.4V$
FEED_A_VALID	1 = FEED_A_TEST_PASS-bit contains a valid result. 0 = No FET-check has been performed after power on.
FEED_B_VALID	1 = FEED_B_TEST_PASS-bit contains a valid result. 0 = No FET-check has been performed after power on.

FET check

This function tests the hot swap and ORing FETs in one feed by briefly turning them off and measuring that the intermediate voltage between hot swap and ORing drops. If the intermediate voltage drops the corresponding FEED_x_TEST_PASS-bit is set else it is cleared. A FET check can only be launched when all of bits 0 through 5 of MFR_FETCHECKSTATUS are cleared. If any of these bits are set when a launch command is given the CMD_IGNORED-bit will be set and the command will be ignored.

Recommended sequence to launch FET check and retrieve result.

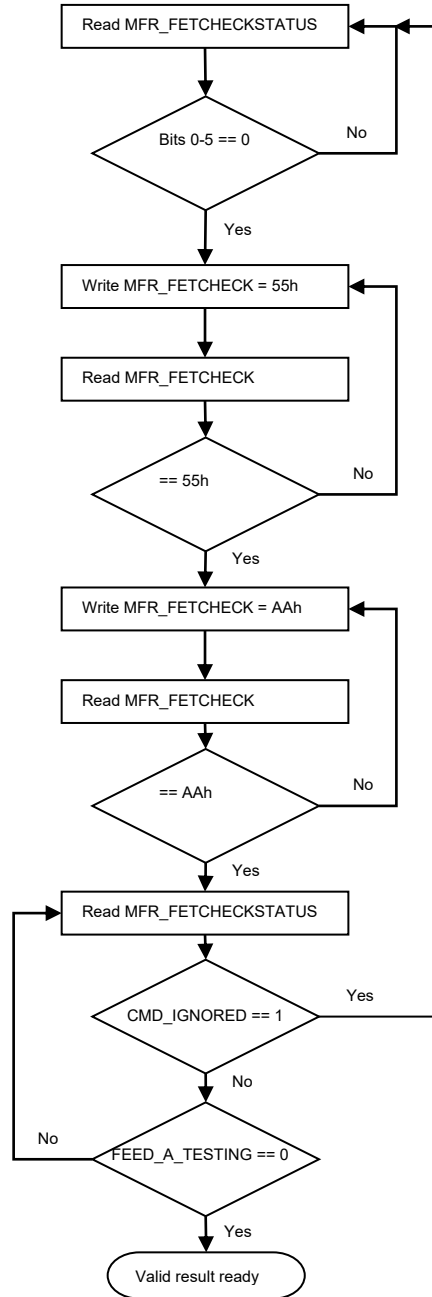

Technical Specification

PIM 4006 SD series Power Interface Module
 Input 36-60 V, Output up to 10.3 A / 100-400 W

28701-BMR45530 Rev D November 2017
 © Flex

Mechanical Information

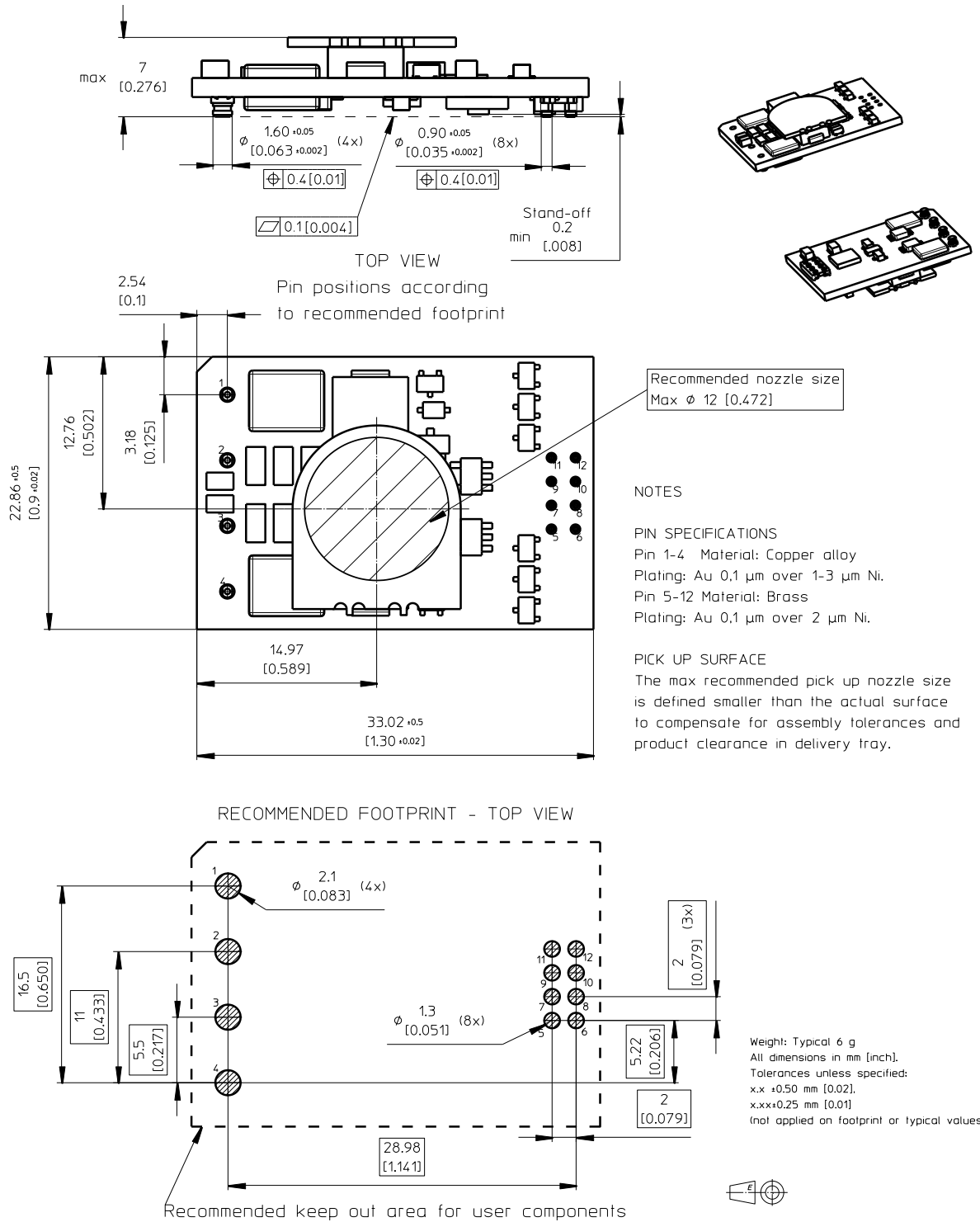

All component placements – whether shown as physical components or symbolical outline – are for reference only and are subject to change throughout the product's life cycle, unless explicitly described and dimensioned in this drawing.

Technical Specification

PIM 4006 SD series Power Interface Module
 Input 36-60 V, Output up to 10.3 A / 100-400 W

28701-BMR45530 Rev D November 2017
 © Flex

Soldering Information - Surface Mounting

The surface mount product is intended for forced convection or vapor phase reflow soldering in SnPb or Pb-free processes.

The reflow profile should be optimised to avoid excessive heating of the product. It is recommended to have a sufficiently extended preheat time to ensure an even temperature across the host PWB and it is also recommended to minimize the time in reflow.

A no-clean flux is recommended to avoid entrapment of cleaning fluids in cavities inside the product or between the product and the host board, since cleaning residues may affect long time reliability and isolation voltage.

General reflow process specifications		SnPb eutectic	Pb-free
Average ramp-up ($T_{PRODUCT}$)		3°C/s max	3°C/s max
Typical solder melting (liquidus) temperature	T_L	183°C	221°C
Minimum reflow time above T_L		60 s	60 s
Minimum pin temperature	T_{PIN}	210°C	235°C
Peak product temperature	$T_{PRODUCT}$	225°C	260°C
Average ramp-down ($T_{PRODUCT}$)		6°C/s max	6°C/s max
Maximum time 25°C to peak		6 minutes	8 minutes

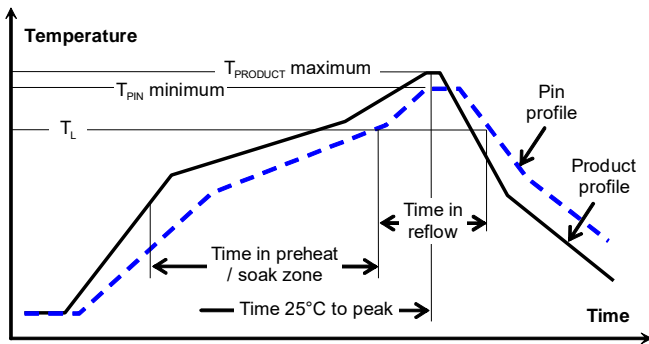

Minimum Pin Temperature Recommendations

Pin number 3 & 4 are chosen as reference locations for the minimum pin temperature recommendation since these will likely be the coolest solder joint during the reflow process.

SnPb solder processes

For SnPb solder processes, a pin temperature (T_{PIN}) in excess of the solder melting temperature, (T_L , 183°C for Sn63Pb37) for more than 60 seconds and a peak temperature of 220°C is recommended to ensure a reliable solder joint.

For dry packed products only: depending on the type of solder paste and flux system used on the host board, up to a recommended maximum temperature of 245°C could be used, if the products are kept in a controlled environment (dry pack handling and storage) prior to assembly.

Lead-free (Pb-free) solder processes

For Pb-free solder processes, a pin temperature (T_{PIN}) in excess of the solder melting temperature (T_L , 217 to 221°C for SnAgCu solder alloys) for more than 60 seconds and a peak temperature of 245°C on all solder joints is recommended to ensure a reliable solder joint.

Maximum Product Temperature Requirements

Top of the product PWB near pin 12 is chosen as reference locations for the maximum (peak) allowed product temperature ($T_{PRODUCT}$) since these will likely be the warmest part of the product during the reflow process.

SnPb solder processes

For SnPb solder processes, the product is qualified for MSL 1 according to IPC/JEDEC standard J-STD-020C.

During reflow $T_{PRODUCT}$ must not exceed 225 °C at any time.

Pb-free solder processes

For Pb-free solder processes, the product is qualified for MSL 3 according to IPC/JEDEC standard J-STD-020C.

During reflow $T_{PRODUCT}$ must not exceed 260 °C at any time.

Dry Pack Information

Products intended for Pb-free reflow soldering processes are delivered in standard moisture barrier bags according to IPC/JEDEC standard J-STD-033 (Handling, packing, shipping and use of moisture/reflow sensitivity surface mount devices).

Using products in high temperature Pb-free soldering processes requires dry pack storage and handling. In case the products have been stored in an uncontrolled environment and no longer can be considered dry, the modules must be baked according to J-STD-033.

Thermocouple Attachment

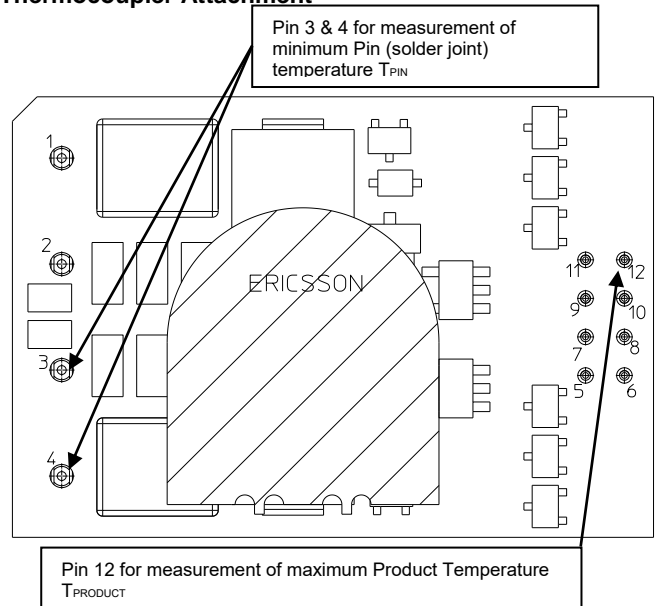

Technical Specification

PIM 4006 SD series Power Interface Module
Input 36-60 V, Output up to 10.3 A / 100-400 W

28701-BMR45530 Rev D November 2017

© Flex

Product Qualification Specification

Characteristics			
External visual inspection	IPC-A-610		
Change of temperature (Temperature cycling)	IEC 60068-2-14 Na	Temperature range Number of cycles Dwell/transfer time	-40 to 100°C 1000 15 min/0-1 min
Cold (in operation)	IEC 60068-2-1 Ad	Temperature T _A Duration	-45°C 72 h
Damp heat	IEC 60068-2-67 Cy	Temperature Humidity Duration	85°C 85 % RH 1000 hours
Dry heat	IEC 60068-2-2 Bd	Temperature Duration	125°C 1000 h
Electrostatic discharge susceptibility	IEC 61340-3-1, JESD 22-A114 IEC 61340-3-2, JESD 22-A115	Human body model (HBM) Machine Model (MM)	Class 2, 2000 V Class 3, 200 V
Immersion in cleaning solvents	IEC 60068-2-45 XA, method 2	Water Glycol ether Isopropyl alcohol	55°C 35°C 35°C
Mechanical shock	IEC 60068-2-27 Ea	Peak acceleration Duration	100 g 6 ms
Moisture reflow sensitivity ¹	J-STD-020C	Level 1 (SnPb-eutectic) Level 3 (Pb Free)	225°C 260°C
Operational life test	MIL-STD-202G, method 108A	Duration	1000 h
Resistance to soldering heat ²	IEC 60068-2-20 Tb, method 1A	Solder temperature Duration	270°C 10-13 s
Robustness of terminations	IEC 60068-2-21 Test Ua1 IEC 60068-2-21 Test Ue1	Through hole mount products Surface mount products	All leads All leads
Solderability	IEC 60068-2-58 test Td ¹	Preconditioning Temperature, SnPb Eutectic Temperature, Pb-free	150°C dry bake 16 h 215°C 235°C
	IEC 60068-2-20 test Ta ²	Preconditioning Temperature, SnPb Eutectic Temperature, Pb-free	Steam ageing 235°C 245°C
Vibration, broad band random	IEC 60068-2-64 Fh, method 1	Frequency Spectral density Duration	10 to 500 Hz 0.07 g ² /Hz 10 min in each direction

Notes

¹ Only for products intended for reflow soldering (surface mount products)

² Only for products intended for wave soldering (plated through hole products)